

CONNECT + CONTROL



Pegler Yorkshire



# PRESS-FIT SYSTEMS FOR DIVERSE APPLICATIONS

CONNECT WITH CONFIDENCE

***XP*ress**





Pegler Yorkshire



# CONNECT WITH CONFIDENCE

With a wealth of expertise and the broadest range of solutions and systems on the market, Pegler Yorkshire's Connect products mean you'll complete your installation as seamlessly, efficiently and effectively as possible.

## TOTAL FUNCTIONALITY, COMPLETE EFFICIENCY

Pegler Yorkshire's range of **Connect** solutions offer innovatively designed, efficient and reliable products and systems that reduce installation time and cost without compromising quality, aesthetics or reliability.

Our **Tectite**, **Henco** and **XPress** product ranges are designed to perform faultlessly in a variety of applications and environments – so you can always be sure to connect with confidence whatever your challenge.

## GLOBAL EXPERIENCE, COMBINED EXPERTISE

With over 100 years of manufacturing and innovation combined with extensive industry knowledge and worldwide market experience, Pegler Yorkshire offers the most advanced and complete **Connect & Control** systems on a global scale.

As one of Britain's largest and most respected manufacturers and suppliers of products for the plumbing and heating industries, Pegler Yorkshire is confident we can provide you with all the connection, control and support your project needs.

For more information visit [www.pegler-yorkshire.co.uk](http://www.pegler-yorkshire.co.uk)





**XPress**

CONNECT + CONTROL

## CONTENTS

*Pegler Yorkshire is pleased to be associated with several influential industry organisations:*



Association of Plumbing and Heating Contractors



The Bathroom Manufacturers Association



The UK Copper Board



Heating and Ventilating Contractors Association

**Brass**

The Brass Page for specifiers, designers, engineers and manufacturers



British Plumbing Employers Council



British Electrotechnical Allied Manufacturers Association



Construction Products Association



The Copper Development Association



Scottish and Northern Ireland Plumbing Employers Federation



Builders Merchants Federation



Institute of Plumbing



The UK District Energy Association



The Chartered Institution of Building Services Engineers



British Automatic Fire Sprinkler Association



Bundesverband Technischer Brandschutz e.V.



EUROPEAN FIRE SPRINKLER NETWORK  
European Fire Sprinkler Network

### 1.0 PRODUCT RANGE OVERVIEW

The complete range

4

Product overview

5-7

Standards, approvals and guarantees

8-9

### 2.0 PRODUCT RANGE DETAILS

Sizes, dimensional details and product codes

10-103

### 3.0 TECHNICAL DATA

Press tools and jaws

104-105

Tube compatibility and fitting applications

106

Materials specifications and manufacturing standards

107

Working temperatures and pressure tables

108-109

Tubes, pipe and their compatibilities

110-112

XPress tube specifications

113-122

System design considerations and tube expansion

123-134

### 4.0 INSTALLATION INSTRUCTIONS

15mm to 35mm sizes

135-138

42mm to 108mm sizes

139-141

### 5.0 FLOW CHARTS

Product flow charts

142



## THE COMPLETE RANGE

XPress fittings from Pegler Yorkshire make jointing easier, faster and more cost effective than other jointing methods - a fittings system which simply presses together in seconds to create a perfect joint, every time.

### **XPRESS PRESS-FIT: COST-EFFECTIVE JOINTING SOLUTIONS FOR SO MANY APPLICATIONS**

Pegler Yorkshire's innovative and comprehensive XPress range delivers all the benefits of a heat-free, press-fit jointing system to a wide variety of domestic, commercial and industrial applications.

XPress also lives up to the promise of its name in every respect: a method which is easy, fast and highly cost-effective, simply pressing together in seconds to create a perfect joint every time, with the guarantee of an uncontaminated installation.

XPress Sprinkler complements the range, and has a dedicated data book. For more information visit [www.pegler-yorkshire.co.uk](http://www.pegler-yorkshire.co.uk)

### **SO MANY XPRESS BENEFITS, AND SO MUCH CHOICE**

- ✚ Major savings in installation time and cost compared with traditional jointing methods
- ✚ A completely heat-free jointing system that requires no additional solders, adhesives, compounds, gas, hotworks permits or costly insurance
- ✚ Clean, rapid, heat-free jointing: no complicated clamping techniques, long preparation procedures or waiting for adhesive to dry
- ✚ Safety: no naked flames
- ✚ Perfectly clean internal bore - less finishing or cleaning required
- ✚ No localised annealing from high-temperature working
- ✚ No carbon deposits, internal solder runs or flux residue - reduced risk of corrosion
- ✚ System does not need to be 'dry' for effective jointing
- ✚ XPress fittings have a wide range of approvals including Kitemark, WRAS and DVGW
- ✚ Electrical continuity assured when the XPress jointing process is complete
- ✚ Ideal for diverse applications such as domestic maintenance and refurbishment, new build and large-scale public sector projects

### **XPRESS RANGE AT A GLANCE**

- ✚ XPress Copper: for hot and cold water services, closed circuit heating, chilled water and oil-free compressed air applications. Incorporating a unique and time-saving Leak Before Press (LBP) design to instantly identify unpressed joints, in 12 to 108mm sizes
- ✚ XPress Carbon: for closed circuit heating and chilled water applications, with LBP feature in 12 to 108mm sizes
- ✚ XPress Stainless: the perfect solution where water quality and hygiene are crucial in food, pharmaceutical and healthcare environments. Also offers LBP in 12 to 108mm sizes
- ✚ XPress Copper Gas: for internal and external above-ground 2nd- and 3rd-family gas services, in 15 to 108mm sizes.
- ✚ XPress Stainless Gas: for use with XPress Stainless System and other stainless steel tubes on above-ground 2nd- and 3rd-family gas pipelines, including applications where high levels of hydrogen sulphide make copper unsuitable. Available in 15 to 108mm sizes.
- ✚ XPress Solar: delivers all the benefits of a heat-free, press-fit jointing system for solar applications. Available in 15 to 54mm sizes.

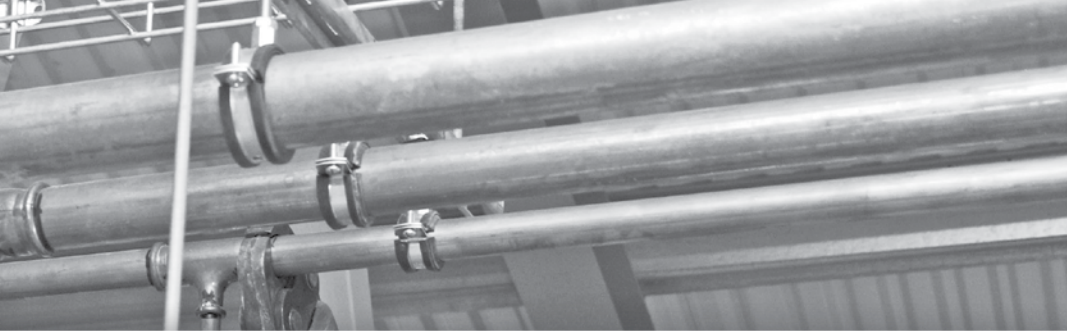

# PRODUCT OVERVIEW

CONNECT + CONTROL

## XPRESS COPPER

XPress Copper fittings are manufactured from copper and copper alloy, incorporating a black EPDM Ethylene Propylene Diene Monomer O ring and a unique "Leak Before Press" (LBP) design. LBP has been developed to provide instant identification of joints that have been assembled correctly but mistakenly left unpressed. This feature saves time, money and potentially expensive callbacks.

Ideal for fast, efficient jointing of copper tube to BS EN 1057 R250 and R290 in sizes 12 to 108mm. XPress fittings are designed for use on hot and cold water services, vented and unvented closed circuit heating, chilled water and oil-free compressed air applications within permissible pressure and temperature limits.

XPress Copper fittings are approved to the new Kitemark certification BS 8537:2010 for use with copper tube as specified above.

## FEATURES

- Manufactured from copper/copper alloy
- Available in sizes 12 to 108mm
- Leak Before Press
- Electrical continuity assured when XPress joint complete
- Clean, heat free jointing
- Safety, no naked flames, no hotwork permits or costly insurance
- Chromium plated range
- Temperature rating from -20 to 110°C
- Pressure rating 16bar throughout the temperature range
- Wide range of approvals
- BSI tested and approved (previously GL, formerly British Gas) for Gas in 15mm to 108mm sizes
- BSI Kitemark approved for Type 1 fittings (water) in sizes 12 to 108mm



## XPRESS STAINLESS

XPress Stainless Steel is optimised for use as a system and fittings are manufactured from 316L (1.4404) stainless steel.

316 System tube is available in straight 6m lengths. 12 to 54mm tube is manufactured from BS 316 831/DIN 1.4401 stainless steel strips conforming to BS 10088 Part 2. Above 54mm the tube conforms to DVGW W541. The fittings incorporate a black EPDM (Ethylene Propylene Diene Monomer) O ring and a unique "Leak Before Press" (LBP) design. LBP has been developed as a final check to the system to provide instant identification of joints that have been assembled correctly but mistakenly left unpressed. This feature saves time, money and potentially expensive call backs.

Designed for potable water applications where water quality and hygiene are crucial, particularly in the food, pharmaceutical and healthcare environments and chilled water applications. Water purified by Reverse Osmosis (RO) is likely to have a low pH and an extremely low dissolved solid content. XPress Stainless provides resistance to RO purified water.

## FEATURES

- Fittings are manufactured from 316L stainless steel
- Tube is manufactured from 316 stainless steel
- Available in sizes 12 to 108mm
- Leak Before Press
- Clean, heat free jointing
- Safety - no naked flames, no hotwork permits or costly insurance
- Wide range of approvals
- Temperature range -35 to 135°C
- Pressure rating 16bar throughout the temperature range
- Light weight, easy to handle
- Suitable for use on XPress Sprinkler stainless steel tubes (LPCB Approved)
- Socket Depth Marking on popular drum ended fittings whilst identifying material type. (Green for Stainless)



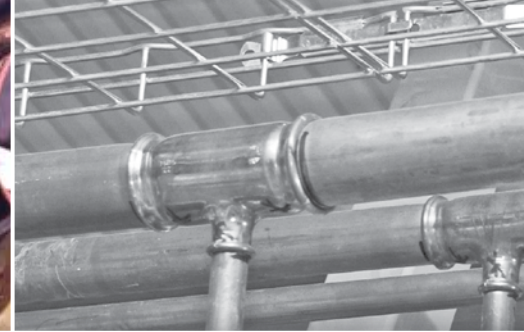

## PRODUCT OVERVIEW

### XPRESS CARBON

XPress Carbon Steel is optimised for use as a system. XPress Carbon Steel fittings are now manufactured from EN 100-27-1S205G2T (formerly known as Rst 34-2) carbon steel.

The fittings incorporate a black EPDM (Ethylene Propylene Diene Monomer) O ring and a unique "Leak Before Press" (LBP) design. LBP has been developed as a final check to the system to provide instant identification of joints that have been assembled correctly but mistakenly left unpressed. This feature saves time, money and potentially expensive call backs.

Each fitting is individually marked indicating material. (Red for Carbon)

XPress Carbon is designed for vented and unvented closed circuit heating and chilled water applications.

### FEATURES

- ✚ Manufactured from carbon steel
- ✚ Galvanised carbon system tube available in 12 to 108mm
- ✚ Plastic coated carbon system tube available in 12 to 54mm
- ✚ Leak Before Press
- ✚ Temperature rating from -35 to 135°C
- ✚ Pressure rating 16bar throughout the temperature range
- ✚ Clean, heat free jointing
- ✚ Safety - no naked flames, no hotwork permits or costly insurance
- ✚ Suitable for use on XPress Sprinkler galvanised tube (SC645) LPCB Approved
- ✚ Socket Depth Marking on popular drum ended fittings whilst identifying material type. (Red for Carbon)



### XPRESS COPPER GAS

XPress Copper Gas fittings are manufactured from copper or copper alloy (typically gunmetal) and incorporate a yellow (HNBR) Hydrogenated Acrylonitrile Butadiene Rubber O ring. XPress Copper Gas fittings do not have the LBP feature for safety reasons.

Designed specifically for use with copper tube to BS EN 1057 on internal and external above ground 2nd and 3rd family gas services and available in sizes 12 to 108mm.

XPress Copper Gas performance, when correctly assembled with copper tube to BS EN 1057 R250 and R290 (for above ground use only), has a minimum operating temperature range of between -20 and 70°C. The maximum working pressure inside buildings is 1bar and maximum working pressure outside buildings is 5bar (maximum test pressure 7.5bar).

XPress Copper Gas fittings are permanently marked with a highly visible yellow marking stating Gas/PN5 GT1 on each fitting.

XPress Copper Gas fittings are approved to the new Kitemark certification BS 8537:2010 for

use with copper tube as specified above. As part of the BSI/DVGW testing and approvals process (previously GL, formerly British Gas), XPress Copper Gas fittings have passed the High Temperature Leakage Rate test at 650°C for 30 minutes.

### FEATURES

- ✚ Manufactured from copper/copper alloy
- ✚ Available in sizes 15mm to 108mm
- ✚ For use in internal and external above ground 2nd and 3rd family gas services (see page 136) – where we locate the gas families
- ✚ Clean, heat free jointing
- ✚ Safety - no naked flames, no hot work permits or costly insurance
- ✚ BSI Kitemark approved for Type 2 fittings (Gas) in sizes 15mm to 108mm





## CONNECT + CONTROL

### XPRESS STAINLESS GAS

XPRESS Stainless Steel Gas is optimised for use as a system. Fittings are manufactured from 316 (BS 316S31/DIN 1.4401) or 316 Ti (BS 320531/DIN 1.4571). The fittings incorporate a yellow HNBR (Hydrogenated Acrylonitrile Butadiene Rubber) O ring. XPRESS Stainless Steel Gas fittings do not have the LBP feature for safety reasons.

Designed for use with 316 System tube or stainless steel tube for BS 4127:1994 and DVGW W541 on internal and external above ground 2nd and 3rd family gas services and available in sizes from 15 to 108mm.

XPRESS Stainless Gas fittings are approved for use at temperatures from -20 to 70°C. The maximum working pressure inside buildings is 1bar and maximum working pressure outside buildings is 5bar (maximum test pressure 7.5bar).

XPRESS Stainless Steel Gas fittings are marked with a highly visible yellow label stating Gas on each fitting.

As part of the DVGW/BSI (formerly GL, British Gas) approvals process, XPRESS Stainless Gas fittings have passed the High Temperature Leakage Rate test at 650°C for 30 minutes at PN5/GT1.

### FEATURES

- ✚ Manufactured from 316 stainless steel
- ✚ Available in sizes 15 to 108mm
- ✚ Designed for use with XPRESS stainless steel system tube
- ✚ For use in internal and external above ground 2nd and 3rd family gas services (see page 136) – where we locate the gas families
- ✚ Clean, heat free jointing
- ✚ Safety - no naked flames, no hotwork permits or costly insurance
- ✚ BSI verified



### XPRESS SOLAR

XPRESS Copper Solar fittings are manufactured from copper and copper alloy and incorporate a green FPM (Fluorocarbon rubber/FPM Viton™) O ring and incorporate the unique "Leak Before Press" (LBP) design. This feature means that any assembled joints inadvertently left unpressed will exhibit a leak during system testing. This enables contractors to easily identify unpressed fittings before commissioning.

XPRESS Copper Solar fittings are available in sizes 15 to 54mm and are marked with a highly visible label stating Solar on each fitting, to confirm that solar fittings have been installed once crimped.

Designed for use in solar applications and for use with most proprietary ethylene glycol and propylene glycol heat transfer fluids in concentrations of up to 40%.

### FEATURES

- ✚ Manufactured from copper/copper alloy
- ✚ Available in sizes 15 to 54mm
- ✚ Leak Before Press
- ✚ Suitable for high temperature solar applications
- ✚ Electrical continuity assured when XPRESS joint complete
- ✚ Clean, heat free jointing
- ✚ Safety - no naked flames, no hotwork permits or costly insurance
- ✚ Temperature rating -20 to 200°C
- ✚ Pressure rating 10bar maximum working pressure





## STANDARDS AND APPROVALS

It is Pegler Yorkshire's policy to provide a range of products and services which meet, or exceed, the requirements of our customers in respect of quality, cost and delivery.

### CURRENT AND FUTURE STANDARDS

We at Pegler Yorkshire are dedicated to designing, developing and manufacturing products of the highest quality. It is on this basis that you can trust the XPress range to achieve all relevant British, European and International standards.

It is a sign of our standing in the industry that we at Pegler Yorkshire are helping to draft this and other new European standards, assisted by our fellow members on the various European standards committees.

So, you can rest assured that whatever developments arise, our products will always meet the latest standards.

Over recent years, tube and fittings for plumbing and heating systems have been subject to a gradual harmonisation of standards. The harmonisation was set to incorporate copper and copper alloy press fittings within pr EN 1254 under Part 7, and more recently, the new British Standard BS 8357:2010.



Independent and robust auditing ensures an excellent high quality standard every time.

BS 8537:2010 - Copper and copper alloys. Plumbing fittings. Specification for press ends of plumbing fittings for use with metallic tubes. Pegler Yorkshire's XPress copper range of press fittings is suitable for use with half-hard and hard copper tube R250 and R290 to BS EN1057.

Kitemark: XPress Copper press fittings: water (Type 1 fittings) in sizes 12 to 108mm and gas (Type 2 fittings) in sizes 12 to 108mm have received the BS 8537:2010 certification.

XPress Stainless Gas is BSI verified in sizes 12 to 108mm in respect of FprEN10352:2012 : Stainless Steel plumbing fittings and fittings with press ends for metallic tubes.



XPress Copper and XPress Stainless Steel fittings are tested and

comply with the requirements of the United Kingdom Water Regulations Byelaws (Scotland). The XPress stainless steel system has been designed to provide optimum performance and cost saving benefits for commercial and industrial potable water applications.

XPress Copper Gas fittings have been tested by the GWI and verified by GL (formerly Advantica/British Gas).



LPS 1234: Issue 1  
Cert No. 1033a & 1033b

The XPress Sprinkler system has been tested and certified in accordance with the LPCB guidelines (TS1599 draft 5) for both the galvanized and stainless

steel system for use in fixed sprinkler systems for above ground applications.

For XPress Sprinkler installations according to LPCB, allowed hazard classes range from LH up to OH3.



The XPress Sprinkler Stainless system has a FM certification for fittings and tubes

according to FM approval standard 1630 and 1920 for application in wet and dry sprinkler system, with a maximum pressure of 175 psi (12.1 bar).

Accordingly the FM system is certified for using XPress stainless steel tubes with material code 1.4401 (AISI 316), 1.4520 (AISI 439) and 1.4521 (AISI 444).



ISO is achieved through the continuous improvement of our Quality Management System in line with the requirements of BS EN ISO 9001: 2008.

### PRODUCT APPROVALS

Approval	Country	XPress Copper (water)	XPress Copper (gas)	XPress Stainless	XPress Stainless (gas)	XPress Carbon
UL/CUL	Canada & USA	-	-	✓	-	✓
DNV	Denmark	✓	-	✓	-	✓
DVGW	Germany	✓	✓	✓	✓	-
Emi	Hungary	✓	-	✓	-	-
ETA	Denmark	✓	-	✓	-	-
FM	USA	-	-	✓	-	✓
GASTEC	Netherlands	-	✓	-	-	-
G-LLOYDS	Germany	-	-	✓	-	✓
GOST-R	Russia	✓	-	-	-	-
KIWA	Netherlands	✓	-	✓	-	-
Kiwa Gastec	Netherlands	-	✓	-	-	-
KVGB	Belgium	-	✓	-	-	-
LPCB	UK	-	-	✓	-	✓
RINA	Italy	-	-	✓	-	✓
SBSC	Sweden	-	-	-	-	✓
Sintef	Norway	✓	-	✓	-	-
SITAC	Sweden	✓	-	✓	-	-
SVGW	Switzerland	-	-	✓	✓	-
TA-Luft	Germany	-	-	✓	-	-
VdS	Germany	-	-	✓	-	✓
WRAS	UK	✓	-	✓	-	-

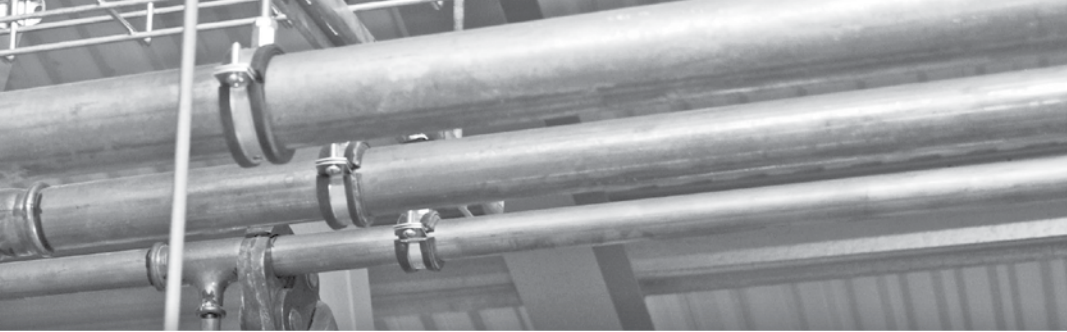

# GUARANTEES

CONNECT + CONTROL

XPRESS GAS APPROVALS										
Approval	Sizes mm	BSI	BSI Kitemark	DG	DVGW	KIWA GASTEC	KVGB	OVGW	CSN	EMI
Certificate/ Registration number	15, 22 and 28	Test Report TR/11/180	Cert No. KM 586758	Cert No. TV-00129	Cert No. DG 4550BL0160	Cert No. Q09-002	Cert No. 3142	Cert No. G2.909	B-30- 00391-11	Approved
	35 - 54	Test Report TR/11/180	Cert No. KM 586758	-	Cert No. DG 4550BL0160	Cert No. Q09-002	-	Cert No. G2.909	B-30- 00391-11	Approved
	66.7 - 108	Test Report TR/11/180	Cert No. KM 586758	-	-	-	-	-	-	-

Information correct at time of print. Visit [www.pegleryorkshire.co.uk](http://www.pegleryorkshire.co.uk)

XPRESS FITTINGS AND TUBE			
Range	Fittings	10 Years	25 Years
<b>XPRESS COPPER</b>	Fittings with copper tube to BS EN 1057 (R250/R290)	-	✓
<b>XPRESS COPPER GAS</b>	Fittings with copper tube to BS EN 1057 (R250/R290)	-	✓
<b>XPRESS STAINLESS</b>	Fittings with XPress Stainless Steel System tube	-	✓
<b>XPRESS CARBON</b>	Fittings with XPress Carbon Steel System tube	✓	-
	Fittings with XPress plastic coated carbon steel System tube	✓	-
<b>XPRESS STAINLESS GAS</b>	Fittings with XPress Stainless Steel System tube	-	✓
<b>XPRESS SOLAR</b>	Fittings with copper tube capable of 200°C temperatures	-	-

To qualify for guarantees, all products must be installed in accordance with our instructions on specified applications.



Please visit the PY website for full dimensional data and drawings

### S1/7270 Straight coupling

Connection: Press x press

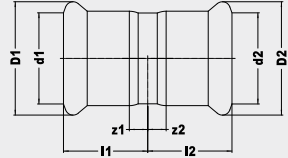

Size	l1	d1	D1	z1	l2	d2	D2	z2	DN1	DN2	Code
12mm	21	12	19	4	21	12	19	4	DN10	DN10	38009
15mm	22	15	23	2	22	15	23	2	DN12	DN12	38010
18mm	22	18	26	2	22	18	26	2	DN15	DN15	38011
22mm	23	22	31	2	23	22	31	2	DN20	DN20	38020
28mm	25	28	37	2	25	28	37	2	DN25	DN25	38030
35mm	28	35	44	2	28	35	44	2	DN32	DN32	38032
42mm	36	42	53	4	36	42	53	4	DN40	DN40	38034
54mm	42	54	65	5	42	54	65	5	DN50	DN50	38035
66.7mm	55	67	83	5	55	67	83	5	DN65	DN65	38036
76.1mm	55	76	94	5	55	76	94	5	DN65	DN65	38037
88.9mm	66	89	108	8	132	89	108	8	DN80	DN80	38039
108mm	72	108	132	5	72	108	132	5	DN100	DN100	38038

### S1FMF/7520 Composite female metric flange PN16

Connection: Press x powder coated steel flange to EN1092-1:1997 (BS4504)

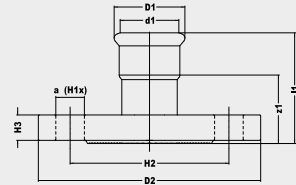

Size	H1	H2	H3	a	l1	d1	D1	z1	D2	DN1	Code
66.7mm DN65 (2 1/2")	4	145	20	18	103	67	83	53	185	DN65	38364
76.1mm DN65 (3")	4	145	20	18	103	76	94	53	-	DN65	38369
76.1mm DN80 (3")	8	160	20	18	103	76	94	53	200	DN80	38365
88.9mm DN80 (3")	8	160	20	18	113	89	108	51	200	DN80	38366
108mm DN100 (4")	8	180	20	18	126	108	132	59	220	DN100	38367

### S1FMM/7520 Composite female metric flange PN16

Male end for insertion into fitting x powder coated steel flange to EN1092-1:1997 (BS4504)

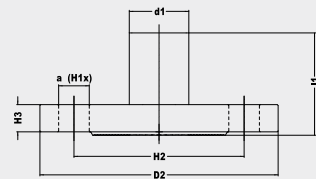
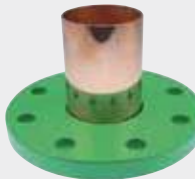

Size	H1	H2	H3	a	l1	d1	DN1	Code
66.7mm DN65 (2 1/2")	4	145	20	18	112	67	DN65	38359
76.1mm DN80 (3")	8	160	20	18	113	76	DN65	38360
108mm DN100 (4")	8	180	20	18	141	108	DN100	38362

## FEATURES

✚ Leak Before Press (LBP) technology identifies joints that have not been pressed correctly in sizes 15mm-54mm

✚ Designed for use in hot and cold water services, closed circuit heating, chilled water and oil free compressed air applications

✚ Heat free jointing provides time and cost saving benefits to contractors/installers

### S1Slip/7270S Straight coupling slip patterning

Connection: Press x press (without tube stop)

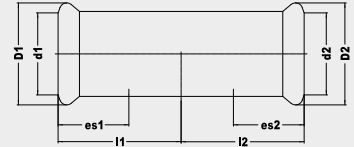

Size	l1	d1	D1	l2	d2	D2	DN1	DN2	Code
15mm	40	15	23	40	15	23	DN12	DN12	38044
18mm	40	18	26	40	18	26	DN15	DN15	38054
22mm	42	22	31	42	22	31	DN20	DN20	38045
28mm	46	28	37	46	28	37	DN25	DN25	38046
35mm	50	35	44	50	35	44	DN32	DN32	38047
42mm	60	42	53	60	42	53	DN40	DN40	38048
54mm	71	54	65	71	54	65	DN50	DN50	38049
66.7mm	55	67	83	55	67	83	DN65	DN65	38040
76.1mm	55	67	83	55	67	83	DN65	DN65	38041
88.9mm	66	76	94	55	76	94	DN65	DN65	38042
108mm	72	108	132	72	108	132	DN100	DN100	38043

### S1R/7240 Straight Reducing Coupling

Press x press

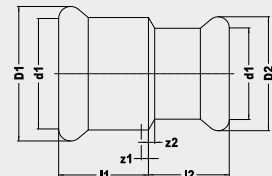

Size	l1	d1	D1	z1	l2	d2	D2	z2	DN1	DN2	Code
15 x 12mm	23	15	23	3	22	12	19	5	DN12	DN10	38063
16 x 15mm	42	16	24	2	-	15	23	-	DN15	DN12	38061
22 x 15mm	28	22	31	7	25	15	23	5	DN20	DN12	38064
28 x 15mm	35	28	37	12	23	15	23	3	DN25	DN12	38065
28 x 22mm	29	28	37	6	26	22	31	5	DN25	DN20	38066
35 x 28mm	33	35	44	7	28	28	37	5	DN32	DN25	38067
42 x 35mm	37	42	53	7	31	35	44	5	DN40	DN32	38068
54 x 42mm	46	54	65	11	34	42	53	4	DN50	DN40	38069



### S2/6270G Straight female connector

Press x BSP parallel female thread

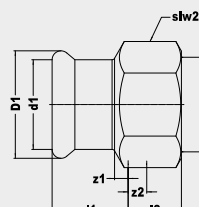

Size	l1	d1	D1	z1	l2	z2	slw2	sks2	DN1	DN2	Code
12mm x Rp3/8"	17	12	19	0	14	6	20	21	DN10	3/8" (DN10)	38082
12mm x Rp1/2"	18	12	19	0	17	8	22	26	DN10	1/2" (DN15)	38081
15mm x Rp3/8"	20	15	23	2	14	6	20	21	DN12	3/4" (DN20)	38083
15mm x Rp1/2"	20	15	23	3	18	8	25	29	DN12	1/2" (DN15)	38090
15mm x Rp3/4"	21	15	23	5	19	8	30	32	DN12	3/8" (DN10)	38091
18mm x Rp1/2"	19	18	26	2	18	8	25	27	DN15	1/2" (DN15)	38084
18mm x Rp3/4"	20	18	26	2	19	9	30	32	DN15	3/4" (DN20)	38085
22mm x Rp1/2"	20	22	31	1	17	7	30	32	DN20	3/4" (DN20)	38086
22mm x Rp3/4"	20	22	31	0	19	9	30	32	DN20	1" (DN25)	38092
22mm x Rp1"	21	22	31	3	22	11	37	39	DN20	1/2" (DN15)	38087
28mm x Rp3/4"	23	28	37	3	17	7	37	39	DN25	1 1/4" (DN32)	38088
28mm x Rp1"	23	28	37	3	22	10	37	39	DN25	3/4" (DN20)	38093
28mm x Rp1 1/4"	24	28	37	2	24	10	46	49	DN25	1" (DN25)	38103
35mm x Rp3/4"	29	35	44	4	15	4	30	32	DN32	1 1/4" (DN32)	38080
35mm x Rp1"	24	35	44	5	22	10	42	44	DN32	3/4" (DN20)	38089
35mm x Rp1 1/4"	25	35	44	3	25	11	46	49	DN32	1" (DN25)	38094
42mm x Rp1 1/4"	30	42	53	0	22	8	46	49	DN40	1 1/2" (DN40)	38101
42mm x Rp1 1/2"	29	42	53	3	25	11	48	56	DN40	1 1/4" (DN32)	38095
54mm x Rp2"	34	54	65	3	25	11	48	56	DN50	1 1/4" (DN32)	38096
64mm x Rp2 1/2"	49	64	80	1	40	9	82	85	DN60	2 1/2" (DN65)	38954



## S3/6243G Straight male connector

Press x BSP male taper thread

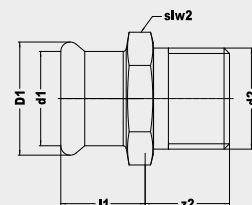

Size	l1	d1	D1	z2	slw2	sks2	DN1	DN2	Code
12mm x R3/8"	17	12	19	9	19	21	DN10	3/8" (DN10)	38105
12mm x R1/2"	17	12	19	11	19	21	DN10	1/2" (DN15)	38106
15mm x R3/8"	20	15	23	7	21	24	DN12	1/2" (DN15)	38107
15mm x R1/2"	20	15	23	8	21	24	DN12	1/2" (DN15)	38114
15mm x R3/4"	20	15	23	10	25	27	DN12	1/2" (DN15)	38115
18mm x R1/2"	20	18	26	9	25	27	DN15	1/2" (DN15)	38108
18mm x R3/4"	20	18	26	10	25	27	DN15	3/4" (DN20)	38109
22mm x R1/2"	21	22	31	9	30	32	DN20	3/4" (DN20)	38110
22mm x R3/4"	21	22	31	10	30	32	DN20	3/4" (DN20)	38116
22mm x R1"	21	22	31	11	32	34	DN20	3/4" (DN20)	38117
28mm x R3/4"	23	28	37	10	36	38	DN25	3/4" (DN20)	38111
28mm x R1"	23	28	37	11	36	38	DN25	1" (DN25)	38118
28mm x R1 1/4"	23	28	37	12	36	42	DN25	1 1/4" (DN32)	38127
35mm x R1"	26	35	44	12	41	44	DN32	1 1/4" (DN32)	38112
35mm x R1 1/4"	26	35	44	15	41	44	DN32	1 1/4" (DN32)	38119
42mm x R1 1/4"	30	42	53	16	51	54	DN40	1 1/4" (DN32)	38113
42mm x R1 1/2"	30	42	53	16	51	53	DN40	1 1/2" (DN40)	38120
54mm x R2"	35	54	65	12	-	66	DN50	2" (DN50)	38121
64mm x R2 1/2"	50	64	80	34	66	76	DN60	2 1/2" (DN65)	38956
66.7mm x R2 1/2"	50	67	83	25	74	82	DN65	2 1/2" (DN65)	38122
76.1mm x R2 1/2"	50	76	94	31	76	88	DN65	2 1/2" (DN65)	38126
76.1mm x R3"	50	76	94	39	77	89	DN65	3" (DN80)	38123
88.9mm x R3"	62	89	108	30	100	105	DN80	3" (DN80)	38125
108mm x R4"	68	108	132	38	107	124	DN100	4" (DN100)	38124



#### S6/7243 Reducer

Larger end male for insertion into fitting x press

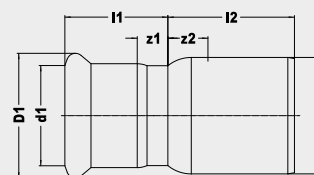

Size	l1	d1	D1	z1	l2	d2	z2	DN1	DN2	Code
15 x 12mm	21	12	19	4	23	15	3	DN10	DN12	38193
18 x 12mm	21	12	19	4	26	18	6	DN10	DN15	38196
18 x 15mm	24	15	23	4	23	18	3	DN12	DN15	38197
22 x 15mm	24	15	23	4	28	22	7	DN12	DN20	38200
22 x 18mm	24	18	26	4	26	22	5	DN15	DN20	38201
28 x 15mm	25	15	23	4	3	28	14	DN12	DN25	38202
28 x 18mm	26	18	26	4	35	28	12	DN15	DN25	38203
28 x 22mm	25	22	31	4	30	28	7	DN20	DN25	38204
35 x 22mm	29	22	31	9	39	35	13	DN20	DN32	38207
35 x 28mm	28	28	37	5	35	35	9	DN25	DN32	38208
42 x 22mm	25	22	31	4	49	42	19	DN20	DN40	38210
42 x 28mm	27	28	37	4	44	42	14	DN25	DN40	38211
42 x 35mm	35	35	44	8	38	42	8	DN32	DN40	38212
54 x 28mm	27	28	37	4	59	54	24	DN25	DN50	38215
54 x 35mm	35	35	44	9	53	54	18	DN32	DN50	38216
54 x 42mm	40	42	53	9	47	54	12	DN40	DN50	38217
66.7 x 28mm	37	28	37	14	72	67	22	DN25	DN65	38218
66.7 x 35mm	40	35	44	14	69	67	19	DN32	DN65	38219
66.7 x 42mm	43	42	53	13	67	67	17	DN40	DN65	38220
66.7 x 54mm	49	54	65	14	63	67	13	DN50	DN65	38221
76.1 x 35mm	39	35	44	13	74	76	24	DN32	DN65	38222
76.1 x 42mm	43	42	53	13	70	76	20	DN40	DN65	38223
76.1 x 54mm	52	54	65	17	64	76	14	DN50	DN65	38224
76.1 x 66.7mm	66	67	83	16	60	76	10	DN65	DN65	38225
108 x 42mm	47	42	53	17	106	108	39	DN40	DN100	38228
108 x 54mm	54	54	65	20	102	108	35	DN50	DN100	38229
108 x 66.7mm	70	67	83	20	96	108	29	DN65	DN100	38230
108 x 76.1mm	70	76	94	20	92	108	25	DN65	DN100	38231



### S7/6246G Female adaptor

Male copper for insertion into a fitting x BSP parallel female thread

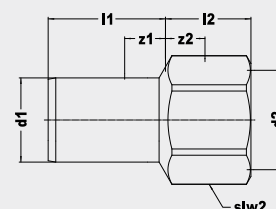

Size	l1	d1	z1	l2	z2	slw2	sks2	DN1	DN2	Code
15mm x 1/2"	30	15	10	18	3	22	26	DN12	1/2" (DN15)	38160
18mm x 1/2"	30	18	10	17	3	33	26	DN15	1/2" (DN15)	38157
18mm x 3/4"	30	18	10	20	3	30	32	DN15	3/4" (DN20)	38158
22mm x 1/2"	30	22	9	17	2	22	26	DN20	1/2" (DN15)	38159
22mm x 3/4"	30	22	9	19	3	30	32	DN20	3/4" (DN20)	38161
28mm x 3/4"	32	28	9	18	2	30	32	DN25	1" (DN25)	38166
28mm x 1"	32	28	9	22	3	37	39	DN25	3/4" (DN20)	38162
35mm x 1"	35	35	9	21	2	37	39	DN32	1" (DN25)	38167
35mm x 1 1/4"	35	35	9	25	4	46	49	DN32	1 1/4" (DN32)	38163
42mm x 1 1/2"	51	42	21	25	4	48	56	DN40	1 1/4" (DN32)	38164
54mm x 2"	56	54	21	30	4	65	70	DN50	2" (DN50)	38165

### S8/6280G Male adaptor

Male copper for insertion into a fitting x BSP male taper thread

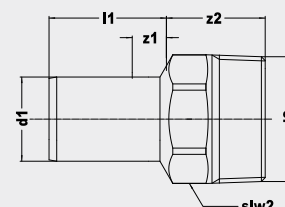

Size	l1	d1	z1	l2	z2	slw2	sks2	DN1	DN2	Code
15mm x 1/2"	30	15	10	21	12	19	21	DN12	1/2" (DN15)	38170
18mm x 1/2"	30	18	10	20	12	19	21	DN15	1/2" (DN15)	38173
18mm x 3/4"	30	18	10	23	14	25	27	DN15	3/4" (DN20)	38174
22mm x 1/2"	30	22	9	21	13	25	27	DN20	1/2" (DN15)	38175
22mm x 3/4"	30	22	9	23	13	25	27	DN20	3/4" (DN20)	38171
28mm x 1"	32	28	9	26	15	32	34	DN25	1" (DN25)	38172
35mm x 1 1/4"	35	35	9	29	16	36	42	DN32	1 1/4" (DN32)	38176
42mm x 1 1/2"	51	42	21	29	16	46	49	DN40	1 1/2" (DN40)	38177



#### S11/6330 Union coupling

Press x press

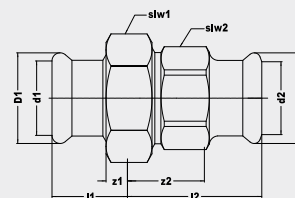

Size	l1	d1	D1	z1	slw1	sks1	l2	d2	D2	z2	slw2	sks2	DN1	DN2	Code
15mm	27	15	23	7	30	34	33	15	23	13	25	27	DN12	DN12	38180
18mm	29	18	26	9	30	34	33	18	26	13	25	27	DN15	DN15	38179
22mm	31	22	31	10	36	41	37	22	31	16	32	34	DN20	DN20	38181
28mm	33	28	37	10	46	49	41	28	37	17	40	42	DN25	DN25	38182
35mm	33	35	44	7	52	56	38	35	44	14	46	46	DN32	DN32	38183
42mm	41	42	53	11	58	61	50	42	53	20	51	54	DN40	DN40	38184
54mm	48	54	65	13	75	79	51	54	65	16	65	70	DN50	DN50	38185

#### S12/7002A Elbow

Press x press



Size	l1	d1	D1	z1	l2	d2	D2	z2	DN1	DN2	Code
12mm	31	12	19	14	31	12	19	14	DN10	DN10	38279
15mm	38	15	23	17	38	15	23	17	DN12	DN12	38280
18mm	42	18	26	22	42	18	26	22	DN15	DN15	38282
22mm	47	22	31	26	47	22	31	26	DN20	DN20	38290
28mm	56	28	37	34	56	28	37	34	DN25	DN25	38300
35mm	68	35	44	42	68	35	44	42	DN32	DN32	38302
42mm	80	42	53	50	80	42	53	50	DN40	DN40	38304
54mm	100	54	65	65	100	54	65	65	DN50	DN50	38306
66.7mm	132	67	83	87	132	67	83	87	DN65	DN65	38307
76.1mm	142	76	94	92	142	76	94	92	DN65	DN65	38308
88.9mm	170	89	108	106	170	89	108	106	DN80	DN80	38309
108mm	201	108	132	135	201	108	132	135	DN100	DN100	38310

#### S12R/7002A Reduced Elbow

Press x press

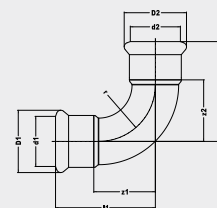

Size	l1	d1	D1	z1	l2	d2	D2	z2	DN1	DN2	Code
22 x 15mm	48	22	31	27	53	15	23	33	DN20	DN15	38311



### S12S/7001A Street Elbow

Press x male end for insertion into an XPress fitting

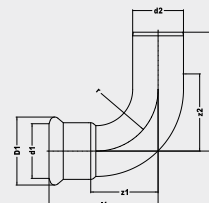

Size	l1	d1	D1	z1	l2	d2	z2	DN1	DN2	Code
12mm	31	12	19	14	45	12	28	DN10	DN10	38317
15mm	36	15	23	16	50	15	30	DN12	DN12	38318
18mm	42	18	26	22	53	18	33	DN15	DN15	38319
22mm	47	22	31	27	58	22	37	DN20	DN20	38320
28mm	58	28	37	34	64	28	41	DN25	DN25	38322
35mm	69	35	44	44	82	35	56	DN32	DN32	38324
42mm	81	42	53	52	101	42	71	DN40	DN40	38325
54mm	100	54	65	66	120	54	85	DN50	DN50	38326
66.7mm	130	67	83	93	175	67	125	DN65	DN65	38327A
76.1mm	143	76	94	93	150	76	100	DN65	DN65	38328
88.9mm	170	89	108	112	178	89	114	DN80	DN80	38329
108mm	197	108	133	130	208	108	144	DN100	DN100	38330A

### S13/6092G Male elbow

Press x BSP male taper thread

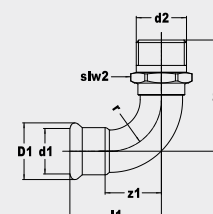

Size	l1	d1	D1	z1	l2	z2	DN1	DN2	Code
12mm x 3/8"	36	12	19	19	25	19	DN10	3/8" (DN10)	38371
12mm x 1/2"	40	12	19	23	26	18	DN10	1/2" (DN15)	38370
15mm x 3/8"	43	15	23	12	24	18	DN12	3/8" (DN10)	38339
15mm x 1/2"	38	15	23	19	34	26	DN12	1/2" (DN15)	38333
18mm x 1/2"	42	18	26	15	37	29	DN15	1/2" (DN15)	38340
18mm x 3/4"	47	18	26	18	31	22	DN15	3/4" (DN20)	38372
22mm x 3/4"	47	22	31	28	43	34	DN20	3/4" (DN20)	38334
28mm x 1"	58	28	37	36	53	43	DN25	1" (DN25)	38335
35mm x 1 1/4"	55	35	44	30	47	35	DN25	1 1/4" (DN32)	38336
42mm x 1 1/2"	62	42	53	32	51	38	DN40	1 1/2" (DN40)	38337
54mm x 2"	70	54	65	35	63	47	DN80	2" (DN50)	38338



#### S14/6090G Female elbow

Connection: Press x BSP parallel female thread

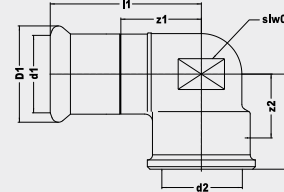

Size	l1	d1	D1	z1	slw0	l2	z2	DN1	DN2	Code
12mm x Rp3/8"	39	12	19	22	15	18	10	DN10	3/8" (DN10)	38346
12mm x Rp1/2"	39	12	19	22	26	20	7	DN10	1/2" (DN15)	38345
15mm x Rp3/8"	43	15	23	23	18	18	11	DN12	3/8" (DN10)	38347
15mm x Rp1/2"	41	15	23	21	18	23	12	DN12	1/2" (DN15)	38351
15mm x Rp3/4"	36	15	23	16	31	29	13	DN12	3/4" (DN20)	38344
18mm x Rp1/2"	41	18	26	21	21	24	14	DN15	1/2" (DN15)	38348
18mm x Rp3/4"	52	18	26	32	21	25	12	DN15	3/4" (DN20)	38349
22mm x Rp1/2"	37	22	31	16	25	32	13	DN20	1/2" (DN15)	38350
22mm x Rp3/4"	45	22	31	24	25	27	11	DN20	3/4" (DN20)	38353
28mm x Rp1"	51	28	37	28	33	33	14	DN25	1" (DN25)	38354
35mm x Rp1 1/4"	55	35	44	29	46	45	21	DN32	1 1/4" (DN32)	38355
42mm x Rp1 1/2"	63	42	53	35	53	52	26	DN40	1 1/2" (DN40)	38356
54mm x Rp2"	74	54	65	42	65	60	33	DN50	2" (DN50)	38357

#### S15/6472G Backplate elbow

Connection: Press x BSP parallel female thread

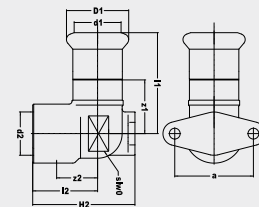

Size	l1	d1	D1	z1	l2	z2	DN1	DN2	Code
12mm x 1/2"	63	12	19	46	25	10	DN10	1/2" (DN15)	38397
15mm x 3/8"	42	15	23	22	38	16	DN12	3/8" (DN10)	38396
15mm x 1/2"	42	15	23	22	20	9	DN12	1/2" (DN15)	38400
18mm x 1/2"	43	18	26	23	24	9	DN15	1/2" (DN15)	38398
22mm x 3/4"	45	22	31	24	27	11	DN20	3/4" (DN20)	38401

#### S15L/6472L Backplate elbow

Connection: Press x parallel female thread

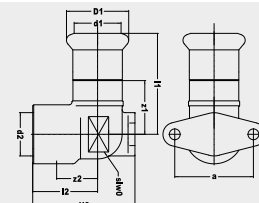

Size	l1	d1	D1	z1	l2	z2	DN1	DN2	Code
15mm x 1/2"	47	15	23	27	48	8	DN12	1/2" (DN15)	38399



### S19/7005 90° bend

Both ends male for insertion into an XPress fitting

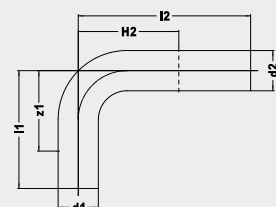

Size	l1	d1	z1	l2	d2	z2	DN1	DN2	Code
15mm	70	15	50	120	15	100	DN12	DN12	38390
18mm	70	18	50	120	18	100	DN15	DN15	38391
22mm	70	22	49	120	22	99	DN20	DN20	38392
28mm	80	28	57	120	28	97	DN25	DN25	38393

### S21/7041 Obtuse Elbow

Press x press

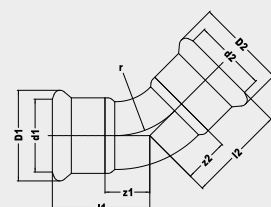

Size	l1	d1	D1	z1	l2	d2	D2	z2	DN1	DN2	Code
12mm	23	12	19	6	23	12	19	6	DN10	DN10	38411
15mm	28	15	23	8	28	15	23	8	DN12	DN12	38410
18mm	29	18	26	9	29	18	26	9	DN15	DN15	38413
22mm	31	22	31	12	31	22	31	12	DN20	DN20	38412
28mm	37	28	37	16	37	28	37	16	DN25	DN25	38414
35mm	44	35	44	18	44	35	44	18	DN32	DN32	38416
42mm	51	42	53	21	51	42	53	21	DN40	DN40	38417
54mm	62	54	65	27	62	54	65	27	DN50	DN50	38418
66.7mm	85	67	83	35	85	67	83	35	DN65	DN65	38419
76.1mm	91	76	94	45	91	76	94	45	DN65	DN65	38420
88.9mm	109	89	108	46	109	89	108	46	DN80	DN80	38422
108mm	125	108	132	59	125	108	132	59	DN100	DN100	38421



#### S21S/7040 Obtuse street elbow

Press x male end for insertion into an XPress fitting

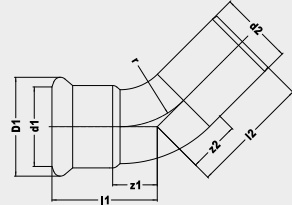

Size	l1	d1	D1	z1	l2	d2	z2	DN1	DN2	Code
12mm	23	12	19	6	32	12	15	DN10	DN10	38402
15mm	28	15	23	8	37	15	17	DN12	DN12	38404
18mm	29	18	26	9	39	18	19	DN15	DN15	38403
22mm	32	22	31	11	44	22	23	DN20	DN20	38405
28mm	37	28	37	14	47	28	24	DN25	DN25	38406
35mm	43	35	44	17	58	35	32	DN32	DN32	38407
42mm	51	42	53	21	71	42	41	DN40	DN40	38408
54mm	62	54	65	27	82	54	47	DN50	DN50	38409
66.7mm	85	67	83	35	88	67	38	DN65	DN65	38430
76.1mm	90	76	94	40	97	76	54	DN65	DN65	38431
88.9mm	109	89	108	47	116	89	54	DN80	DN80	38433
108mm	115	108	133	48	136	108	69	DN100	DN100	38432A

#### S22/7086 Partial crossover

Press x male end for insertion into an XPress fitting

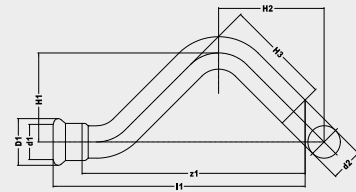

Size	l1	d1	D1	z1	d2	DN1	DN2	Code
15mm	110	15	23	90	15	DN12	DN12	38435
18mm	120	18	26	100	18	DN15	DN15	38437
22mm	134	22	31	113	22	DN20	DN20	38436

#### S22S/7087 Street crossover

Both ends male for insertion into an XPress fitting

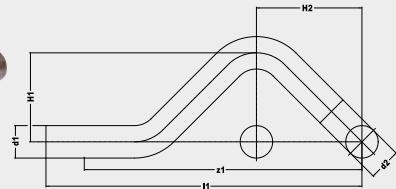

Size	l1	d1	d2	DN1	DN2	Code
15mm	118	15	15	DN12	DN12	38438
18mm	128	18	18	DN15	DN15	38434
22mm	142	22	22	DN20	DN20	38439



### S23/7085 Full crossover

Press x press

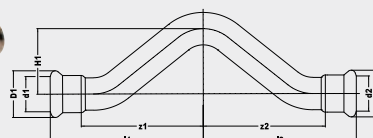

Size	l1	d1	D1	z1	l2	d2	D2	z2	DN1	DN2	Code
15mm	70	15	23	50	70	15	23	50	DN12	DN12	38440
18mm	76	18	26	56	76	18	26	56	DN15	DN15	38442
22mm	85	22	31	64	85	22	31	64	DN20	DN20	38441

### S24/7130 Equal tee

Press x press

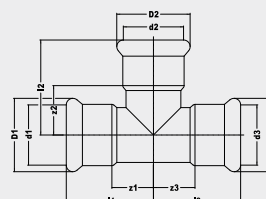
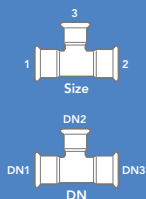

Size	l1	d1	D1	z1	l2	d2	D2	z2	l3	d3	D3	z3	DN1	DN2	DN3	Code
12mm	28	12	19	11	28	12	19	11	28	12	19	11	DN10	DN10	DN10	38472
15mm	32	15	23	12	32	15	23	12	32	15	23	12	DN12	DN12	DN12	38450
18mm	34	18	26	14	34	18	26	14	34	18	26	14	DN15	DN15	DN15	38451
22mm	37	22	31	16	37	22	31	16	37	22	31	16	DN20	DN20	DN20	38460
28mm	42	28	37	19	42	28	37	19	42	28	37	19	DN25	DN25	DN25	38462
35mm	50	35	44	24	50	35	44	24	50	35	44	24	DN32	DN32	DN32	38464
42mm	58	42	53	28	58	42	53	28	58	42	53	28	DN40	DN40	DN40	38466
54mm	69	54	65	34	69	54	65	34	69	54	65	34	DN50	DN50	DN50	38467
66.7mm	95	67	83	45	111	67	83	61	95	67	83	45	DN65	DN65	DN65	38468A
76.1mm	101	76	94	51	119	76	94	69	101	76	94	51	DN65	DN65	DN65	38469A
88.9mm	162	-	-	100	162	-	-	100	162	-	-	100	DN80	DN80	DN80	38470A
108mm	136	108	133	69	154	108	133	87	136	108	133	69	DN100	DN100	DN100	38471A



### S25/7130 Tee, reduced branch

Press on all ends

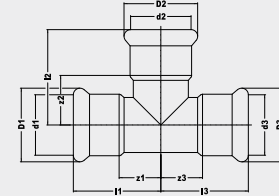
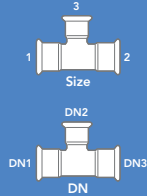

Size	l1	d1	D1	z1	l2	d2	D2	z2	l3	d3	D3	z3	DN1	DN2	DN3	Code
15 x 15 x 12mm	32	15	23	12	32	12	19	15	32	15	23	12	DN12	DN10	DN12	38488
18 x 18 x 12mm	34	18	26	14	35	12	19	15	34	18	26	14	DN15	DN10	DN15	38452
18 x 18 x 15mm	34	18	26	14	35	15	23	15	34	18	26	14	DN15	DN12	DN15	38454
22 x 22 x 12mm	37	22	31	16	34	12	19	17	37	22	31	16	DN20	DN10	DN20	38491
22 x 22 x 15mm	37	22	31	16	38	15	23	18	37	22	31	16	DN20	DN12	DN20	38490
22 x 22 x 18mm	37	22	31	16	38	18	26	18	37	22	31	16	DN20	DN15	DN20	38535
28 x 28 x 12mm	42	28	37	19	37	12	19	20	42	28	37	19	DN25	DN10	DN25	38493
28 x 28 x 15mm	42	28	37	19	41	15	23	21	42	28	37	19	DN25	DN12	DN25	38492
28 x 28 x 18mm	42	28	37	19	41	18	26	21	42	28	37	19	DN25	DN15	DN25	38538
28 x 28 x 22mm	42	28	37	19	41	22	31	20	42	28	37	19	DN25	DN20	DN25	38494
35 x 35 x 15mm	45	35	44	19	44	15	23	24	45	35	44	19	DN32	DN12	DN32	38496
35 x 35 x 22mm	45	35	44	19	45	22	31	24	45	35	44	19	DN32	DN20	DN32	38497
35 x 35 x 28mm	50	35	44	24	44	28	37	21	50	35	44	24	DN32	DN25	DN32	38498
42 x 42 x 15mm	50	42	53	20	48	15	23	28	50	42	53	20	DN40	DN12	DN40	38499
42 x 42 x 22mm	50	42	53	20	48	22	31	27	50	42	53	20	DN40	DN20	DN40	38500
42 x 42 x 28mm	56	42	53	26	49	28	37	26	56	42	53	26	DN40	DN25	DN40	38501
42 x 42 x 35mm	56	42	53	26	50	35	44	24	56	42	53	26	DN40	DN32	DN40	38502
54 x 54 x 22mm	60	54	65	25	54	22	31	33	60	54	65	25	DN50	DN20	DN50	38504
54 x 54 x 28mm	60	54	65	25	55	28	37	32	60	54	65	25	DN50	DN25	DN50	38505
54 x 54 x 35mm	61	54	65	24	55	35	44	29	61	54	65	24	DN50	DN32	DN50	38506
54 x 54 x 42mm	69	54	65	34	64	42	53	34	69	54	65	34	DN50	DN40	DN50	38507
66.7 x 66.7 x 28mm	76	67	83	26	67	28	37	43	76	67	83	26	DN65	DN25	DN65	38550
66.7 x 66.7 x 35mm	80	67	83	29	70	35	44	43	80	67	83	29	DN65	DN32	DN65	38560
66.7 x 66.7 x 42mm	82	67	83	32	76	42	53	41	82	67	83	32	DN65	DN40	DN65	38561
66.7 x 66.7 x 54mm	88	67	83	47	78	54	65	43	88	67	83	47	DN65	DN50	DN65	38562
76.1 x 76.1 x 22mm	73	76	94	22	73	22	31	50	73	76	94	22	DN65	DN20	DN65	38563
76.1 x 76.1 x 28mm	77	76	94	26	73	28	37	50	77	76	94	26	DN65	DN25	DN65	38564
76.1 x 76.1 x 35mm	80	76	94	30	78	35	44	53	80	76	94	30	DN65	DN32	DN65	38553
76.1 x 76.1 x 42mm	103	76	94	55	106	42	53	70	103	76	94	55	DN65	DN40	DN65	38551
76.1 x 76.1 x 54mm	93	76	94	41	85	54	65	50	93	76	94	60	DN65	DN50	DN65	38552
108 x 108 x 54mm	109	108	133	125	125	54	65	91	109	108	133	125	DN100	DN54	DN100	38555A
108 x 108 x 66.7mm	117	108	133	46	141	67	83	96	117	108	133	50	DN100	DN65	DN100	38565A
108 x 108 x 76.1mm	120	108	133	52	139	76	94	52	120	108	133	53	DN100	DN80	DN100	38557A
108 x 108 x 88.9mm	126	108	133	59	151	89	108	89	126	108	133	59	DN100	DN80	DN100	38558A



### S26/7130 Tee, one end reduced

Press on all ends

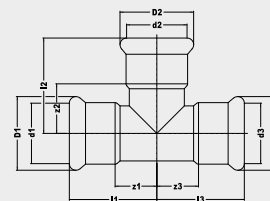
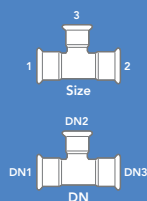

Size	l1	d1	D1	z1	l2	d2	D2	z2	l3	d3	D3	z3	DN1	DN2	DN3	Code
15 x 12 x 15mm	32	15	23	12	32	15	23	12	36	12	19	19	DN12	DN12	DN10	38508
18 x 15 x 18mm	34	18	26	14	34	18	26	14	42	15	23	22	DN15	DN15	DN12	38455
22 x 15 x 22mm	37	22	31	16	37	22	31	16	46	15	23	26	DN20	DN20	DN12	38510
22 x 18 x 22mm	37	22	31	16	37	22	31	16	43	18	26	23	DN20	DN20	DN15	38511
28 x 15 x 28mm	42	28	37	19	42	28	37	19	55	15	23	35	DN25	DN25	DN12	38512
28 x 22 x 28mm	42	35	44	19	42	35	44	19	52	22	31	31	DN32	DN32	DN20	38514
35 x 22 x 35mm	51	35	44	25	50	35	44	24	72	22	31	51	DN32	DN32	DN20	38517
35 x 28 x 35mm	51	35	44	25	50	35	44	24	67	28	37	41	DN32	DN32	DN25	38518

### S27/7130 Tee, one end and branch reduced

Press on all ends

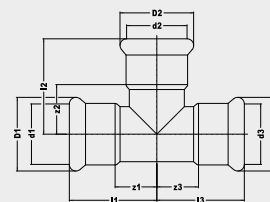
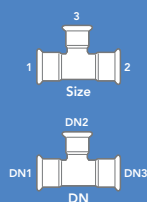

Size	l1	d1	D1	z1	l2	d2	D2	z2	l3	d3	D3	z3	DN1	DN2	DN3	Code
15 x 12 x 12mm	32	15	23	12	32	12	19	15	32	12	19	15	DN12	DN10	DN10	38527
18 x 15 x 15mm	34	18	26	14	35	15	23	15	40	15	23	20	DN15	DN12	DN12	38453
22 x 15 x 15mm	37	22	31	16	44	15	23	18	43	15	23	23	DN20	DN12	DN12	38530
22 x 18 x 15mm	37	22	31	16	44	15	23	18	34	18	26	14	DN20	DN12	DN15	38531
22 x 15 x 18mm	37	22	31	16	38	18	26	18	44	15	23	24	DN20	DN15	DN12	38533
22 x 18 x 18mm	37	22	31	16	38	18	26	18	41	18	26	21	DN20	DN15	DN15	38534
28 x 22 x 18mm	42	28	37	19	41	18	26	21	47	22	31	26	DN25	DN15	DN20	38529
28 x 22 x 15mm	42	28	37	19	41	15	23	21	46	22	31	25	DN25	DN12	DN20	38536
28 x 22 x 22mm	42	28	37	19	41	22	31	20	49	22	31	28	DN25	DN20	DN20	38532
35 x 22 x 22mm	51	35	44	25	44	22	31	23	67	22	31	45	DN32	DN20	DN20	38539
35 x 28 x 22mm	51	35	44	25	44	22	31	23	63	28	37	40	DN32	DN20	DN25	38541
35 x 28 x 28mm	51	35	44	25	44	28	37	21	67	28	37	44	DN32	DN25	DN25	38542
42 x 35 x 35mm	56	42	53	26	50	35	44	24	74	35	44	48	DN40	DN32	DN32	38546
54 x 42 x 42mm	69	54	65	34	64	42	53	34	83	42	53	53	DN50	DN40	DN40	38566



### S28/7130 Tee, both ends reduced

Press on all ends

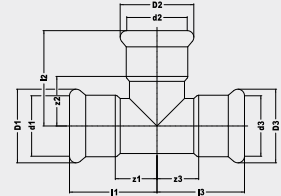
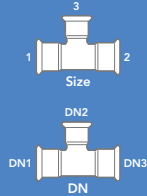

Size	l1	d1	D1	z1	l2	d2	D2	z2	l3	d3	D3	z3	DN1	DN2	DN3	Code
12 x 12 x 15mm	36	12	19	19	32	12	19	15	36	12	19	15	DN10	DN10	DN10	38447
15 x 15 x 18mm	35	15	23	15	32	18	26	12	23	15	23	35	DN12	DN15	DN12	38547
15 x 15 x 22mm	38	15	23	18	34	22	31	13	23	15	23	38	DN12	DN20	DN12	38545
22 x 22 x 28mm	52	22	31	31	42	22	31	19	52	22	31	31	DN20	DN20	DN20	38548
28 x 28 x 35mm	68	28	37	45	50	28	37	24	37	28	37	68	DN25	DN25	DN25	38549

### S30/6130G Female branch tee

Press x BSP parallel female branch

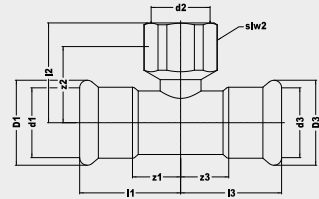
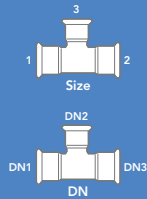

Size	l1	d1	D1	z1	l2	z2	slw2	sks2	l3	d3	D3	z3	DN1	DN2	DN3	Code
12 x 12mm x Rp1/2"	34	12	19	14	26	10	26	28	34	12	19	14	DN10	1/2" (DN15)	DN10	38584
15 x 15mm x Rp1/2"	34	15	23	14	25	13	26	28	34	15	23	14	DN12	1/2" (DN15)	DN12	38585
18 x 18mm x Rp1/2"	42	18	26	22	24	8	26	28	42	18	26	22	DN15	1/2" (DN15)	DN15	38586
22 x 22mm x Rp1/2"	42	22	31	21	26	11	26	28	42	22	31	21	DN20	1/2" (DN15)	DN20	38591
22 x 22mm x Rp3/4"	45	22	31	24	27	11	32	34	45	22	31	24	DN20	3/4" (DN20)	DN20	38587
28 x 28mm x Rp1/2"	44	28	37	21	29	14	26	28	44	28	37	21	DN25	1/2" (DN15)	DN25	38592
28 x 28mm x Rp3/4"	42	28	37	19	35	14	32	34	42	28	37	19	DN25	3/4" (DN20)	DN25	38593
35 x 35mm x Rp1/2"	50	35	44	24	34	19	26	28	50	35	44	24	DN32	1/2" (DN15)	DN32	38594
42 x 42mm x Rp1/2"	57	42	53	27	38	23	26	28	57	42	53	27	DN40	1/2" (DN15)	DN40	38596
54 x 54mm x Rp1/2"	69	54	65	34	44	29	26	28	69	54	65	34	DN50	1/2" (DN15)	DN50	38597
76.1 x 76.1mm x Rp1/2"	65	76	94	15	48	30	N/A	N/A	65	76	94	15	DN65	1/2" (DN15)	DN65	38190
108 x 108mm x Rp1/2"	82	108	132	15	65	53	N/A	N/A	82	108	132	15	DN100	1/2" (DN15)	DN100	38191



### S32/6131G

#### Female branch tee with multi ports

Press x press

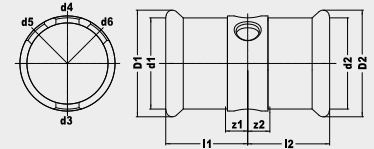

Size	l1	d1	D1	es1	z1	l2	d2	D2	es2	z2	DN1	DN2	DN3	DN4	DN5	DN6	Code
66.7mm x 1/2"	65	67	83	65	15	65	67	83	51	15	DN65	DN65	1/2" (DN15)	1/2" (DN15)	N/A	N/A	38189
76.1mm x 1/2"	65	76	94	65	14	65	76	94	51	14	DN65	DN65	1/2" (DN15)	1/2" (DN15)	N/A	N/A	38188
88.9mm x 3/4"	80	89	108	80	18	80	89	108	62	18	DN80	DN80	3/4" (DN20)	3/4" (DN20)	3/4" (DN20)	N/A	38192
108mm x 3/4"	85	108	132	85	18	85	108	132	68	18	DN100	DN100	3/4" (DN20)	3/4" (DN20)	3/4" (DN20)	3/4" (DN20)	38206

### S60

#### Stop end

Male end for insertion into an XPress fitting

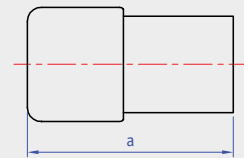

Size	l1	d1	es1	z1	DN1	Code
35mm	96	35	26	70	DN32	38686
42mm	108	42	32	76	DN40	38688
54mm	125	54	37	89	DN50	38690

### S61/7301

#### Stop end

Male end for insertion into an XPress fitting

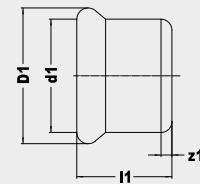

Size	l1	d1	D1	z1	DN1	Code
12mm	17	12	19	2	DN10	38702
15mm	20	15	23	2	DN12	38695
18mm	20	18	26	2	DN15	38696
22mm	21	22	31	2	DN20	38697
28mm	23	28	37	2	DN25	38698
35mm	26	35	44	2	DN32	38699
42mm	30	42	53	2	DN40	38700
54mm	35	54	65	2	DN50	38701
66.7mm	50	67	83	2	DN65	38691
76.1mm	50	76	94	2	DN65	38692
108mm	67	108	132	2	DN100	38694



### S65F/6096G Bent female union connector

Press x parallel female end

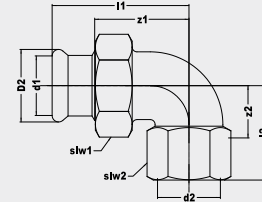

Size	l1	d1	D1	z1	slw1	sks1	l2	z2	slw2	sks2	DN1	DN2	Code
12mm x 1/2"	49	12	19	32	30	34	32	15	27	30	DN10	1/2" (DN15)	38790
15mm x 1/2"	53	15	23	33	30	34	32	17	27	30	DN12	1/2" (DN15)	38791
18mm x 1/2"	55	18	26	35	30	34	32	17	27	30	DN15	1/2" (DN15)	38792
18mm x 3/4"	61	18	26	41	36	41	36	20	33	36	DN15	3/4" (DN20)	38793
22mm x 3/4"	66	22	31	45	36	41	40	21	40	43	DN20	1" (DN25)	38794
22mm x 1"	62	22	31	41	36	41	36	20	33	36	DN20	3/4" (DN20)	38795
28mm x 1"	68	28	37	45	46	50	44	25	40	43	DN25	1" (DN25)	38796

### S68FF/6359 Union

Press x female union end

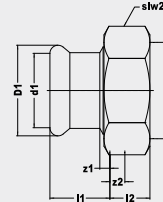

Size	l1	d1	D1	z1	slw1	sks1	l2	z2	DN1	DN2	Code
15mm x G3/4"	30	15	23	10	30	34	11	3	DN12	3/4" (DN20)	38235
18mm x G3/4"	28	18	26	8	30	34	11	3	DN15	3/4" (DN20)	38237
22mm x G1"	36	22	31	15	36	41	13	3	DN20	1" (DN25)	38238
28mm x G1 1/4"	36	28	44	13	46	50	14	4	DN25	1 1/4" (DN32)	38239
35mm x G1 1/2"	36	35	44	10	52	56	15	4	DN32	1 1/2" (DN40)	38242
42mm x G1 3/4"	44	42	53	14	58	61	17	4	DN40	1 3/4"	38243



## S69/6331G Straight male union connector

Press x BSP taper male thread

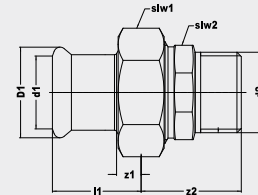

Size	l1	d1	D1	z1	slw1	sks1	l2	z2	slw2	sks2	DN1	DN2	Code
12mm x R3/8"	21	12	19	3	24	25	27	21	19	21	DN10	3/8" (DN10)	38807
12mm x R1/2"	22	12	19	5	27	28	32	23	25	27	DN10	1/2" (DN15)	38808
15mm x R1/2"	30	15	23	10	30	34	32	24	25	27	DN12	1/2" (DN15)	38813
15mm x R3/4"	25	15	23	5	30	34	33	23	25	27	DN12	3/4" (DN20)	38809
18mm x R1/2"	28	18	26	8	30	34	31	23	25	27	DN15	1/2" (DN15)	38810
18mm x R3/4"	28	18	26	8	30	34	33	24	25	27	DN15	3/4" (DN20)	38811
22mm x R1/2"	29	22	31	8	36	41	37	28	32	34	DN20	1/2" (DN15)	38812
22mm x R3/4"	36	22	31	15	36	41	38	28	32	34	DN20	3/4" (DN20)	38814
22mm x R1"	29	22	31	8	36	41	39	28	32	34	DN20	1" (DN25)	38815
28mm x R3/4"	36	28	37	13	46	50	39	30	40	42	DN25	3/4" (DN20)	38820
28mm x R1"	36	28	37	13	46	50	40	30	40	42	DN25	1" (DN25)	38816
35mm x R1 1/4"	36	35	44	10	52	56	43	24	46	48	DN32	1 1/4" (DN32)	38817
42mm x R1 1/2"	44	42	53	14	58	61	44	31	51	54	DN40	1 1/2" (DN40)	38818
54mm x R2"	52	54	65	17	75	79	49	33	65	70	DN50	2" (DN50)	38819

## S69F/6330G Straight female union connector

Press x BSP parallel female thread

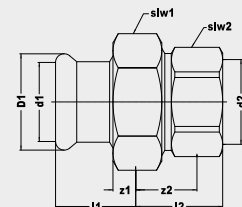

Size	l1	d1	D1	z1	slw1	sks1	l2	z2	slw2	sks2	DN1	DN2	Code
12mm x Rp1/2"	22	12	19	5	27	28	20	5	26	27	DN10	1/2" (DN15)	38828
15mm x Rp1/2"	30	15	23	10	30	34	22	7	26	27	DN12	1/2" (DN15)	38833
15mm x Rp3/4"	25	15	23	5	30	34	30	13	32	34	DN12	3/4" (DN20)	38829
18mm x Rp1/2"	28	18	23	8	30	34	20	5	26	27	DN15	1/2" (DN15)	38830
18mm x Rp3/4"	28	18	23	8	30	34	29	13	32	34	DN15	3/4" (DN20)	38831
22mm x Rp3/4"	36	22	31	14	36	41	32	15	39	40	DN20	1" (DN25)	38834
22mm x Rp1"	29	22	31	8	36	41	36	17	32	34	DN20	3/4" (DN20)	38832
28mm x Rp3/4"	36	28	37	13	46	50	32	16	32	34	DN25	3/4" (DN20)	38827
28mm x Rp1"	36	28	37	13	46	50	29	10	43	45	DN25	1" (DN25)	38835
35mm x Rp1 1/4"	36	35	44	9	52	56	38	17	48	50	DN32	1 1/4" (DN32)	38836
42mm x 1 1/2"	44	42	53	14	58	61	39	18	55	57	DN40	1 1/2" (DN40)	38837
54mm x 2"	52	54	65	17	75	79	38	12	65	70	DN50	2" (DN50)	38838

# CHROMIUM PLATED PRESS FITTINGS FOR JOINTING CHROMIUM PLATED COPPER TUBE



Please visit the PY website for full dimensional data and drawings

### S1CP/7270 Straight coupling

Press x press

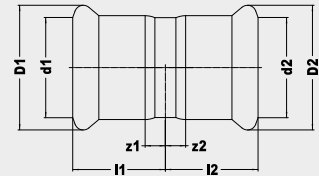

Size	l1	d1	D1	z1	l2	d2	D2	z2	DN1	DN2	Code
12mm	21	12	19	4	21	12	19	4	DN10	DN12	38610
15mm	22	15	23	2	22	15	23	2	DN12	DN12	38611
22mm	23	22	31	2	23	22	31	2	DN20	DN20	38612

### S1SCP/7270S Slip straight coupling slip pattern

Press x press (without tube stop)

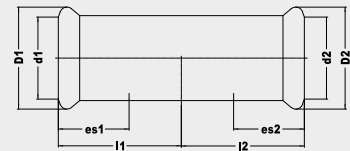

Size	l1	d1	D1	z1	l2	d2	D2	DN1	DN2	Code
15mm	40	15	23	20	40	15	23	DN12	DN12	38614

### S1RCP/7240S Straight reducing coupling

Press x press

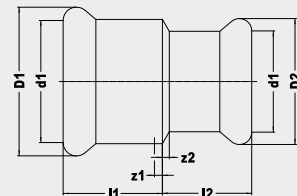

Size	l1	d1	D1	z1	l2	d2	D2	z2	DN1	DN2	Code
15 x 12mm	23	15	23	3	22	12	19	5	DN12	DN10	38616
22 x 15mm	28	22	31	7	25	15	23	5	DN20	DN12	38617

### S2CP/6270G Straight female connector

Press x BSP parallel female thread

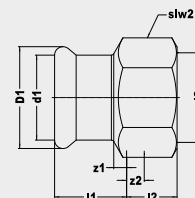

Size	l1	d1	D1	z1	l2	z2	slw2	sks2	DN1	DN2	Code
12mm x Rp3/8"	17	12	19	0	14	6	20	21	DN10	3/8" (DN10)	38619
12mm x Rp1/2"	18	12	19	0	17	8	22	26	DN10	1/2" (DN15)	38620
15mm x Rp3/8"	20	15	23	2	14	6	20	21	DN12	3/4" (DN20)	38621
15mm x Rp1/2"	20	15	23	3	18	8	25	29	DN12	1/2" (DN15)	38622

## FEATURES

✚ Leak Before Press (LBP) technology identifies joints that have not been pressed correctly

✚ Suitable for connecting to copper tube to BS EN 1057 (R250/R290)

✚ Designed with a chromium plate finish to complement any room design where exposed pipework is a feature

### S3CP/6243G Straight male connector

Press x BSP taper male thread

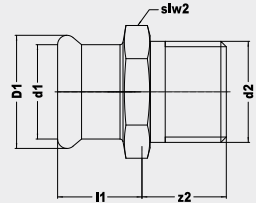

Size	l1	d1	D1	z2	slw2	sks2	DN1	DN2	Code
12mm x R3/8"	17	12	19	9	19	21	DN10	3/8" (DN10)	38627
12mm x R1/2"	17	12	19	11	19	21	DN10	1/2" (DN15)	38628
15mm x R3/8"	20	15	23	7	21	24	DN12	1/2" (DN15)	38629
15mm x R1/2"	20	15	23	8	21	24	DN12	1/2" (DN15)	38630

### S6CP/7243 Reducer

Larger end male for insertion into fitting x press

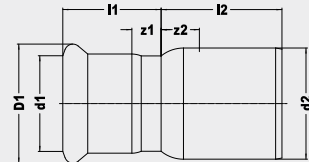

Size	l1	d1	D1	z1	l2	d2	z2	DN1	DN2	Code
15 x 12mm	21	12	19	4	23	15	3	DN10	DN12	38636
18 x 12mm	21	12	19	4	26	18	6	DN10	DN15	38637
18 x 15mm	24	15	23	4	23	18	3	DN12	DN15	38638
22 x 15mm	21	15	23	4	28	22	7	DN12	DN20	38639

### S8CP/6280G Male adaptor

Male end for insertion into a fitting with BSP male taper thread

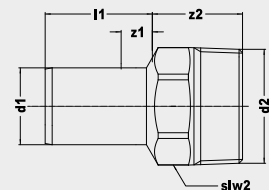

Size	l1	d1	z1	l2	z2	slw2	sks2	DN1	DN2	Code
15mm x 1/2"	30	15	10	21	12	19	21	DN12	1/2" (DN15)	38642

### S12CP/7002A Elbow

Press x press

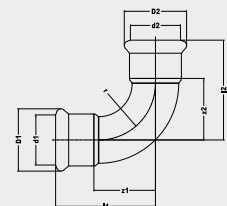

Size	l1	d1	D1	z1	l2	d2	D2	z2	DN1	DN2	Code
12mm	31	12	19	14	31	12	19	14	DN10	DN10	38645
15mm	38	15	23	17	38	15	23	17	DN12	DN12	38646
22mm	47	22	31	26	47	22	31	26	DN20	DN20	38647

# CHROMIUM PLATED PRESS FITTINGS FOR JOINTING CHROMIUM PLATED COPPER TUBE



### S12SCP/7001A Street elbow

Press x male end for insertion into an XPress fitting

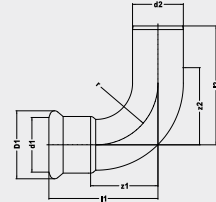

Size	l1	d1	D1	z1	l2	d2	z2	DN1	DN2	Code
12mm	31	12	19	14	45	12	28	DN10	DN10	38649
15mm	36	15	23	16	50	15	30	DN12	DN12	38650
22mm	47	22	31	27	58	22	33	DN20	DN20	38651

### S13CP/6092G Male elbow

Press x BSP taper male thread

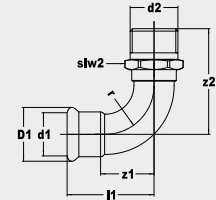

Size	l1	d1	D1	z1	l2	z2	DN1	DN2	Code
12mm x R1/2"	40	12	19	23	26	18	DN10	1/2" (DN15)	38654
15mm x R1/2"	38	15	23	19	34	26	DN12	1/2" (DN15)	38655

### S14CP/6090G Female elbow

Press x BSP parallel female thread

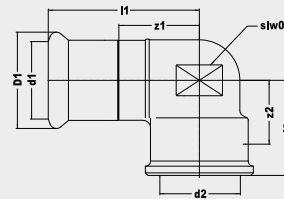

Size	l1	d1	D1	z1	slw0	l2	z2	DN1	DN2	Code
12mm x Rp3/8"	39	12	19	22	15	18	10	DN10	3/8" (DN10)	38659
15mm x Rp1/2"	41	15	23	21	18	23	12	DN12	1/2" (DN15)	38660

### S15CP/6472G Backplate elbow

Press x BSP parallel female thread

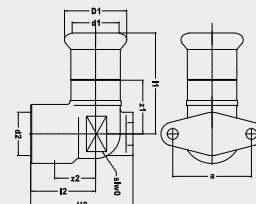

Size	l1	d1	D1	z1	l2	z2	DN1	DN2	Code
12mm x 1/2"	63	12	19	46	25	10	DN10	1/2" (DN15)	38665
15mm x 1/2"	42	15	23	22	20	9	DN12	1/2" (DN15)	38666



### S21CP/7041 Obtuse elbow

Press x press

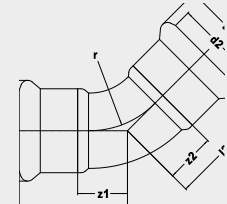

Size	l1	d1	D1	z1	l2	d2	D2	z2	DN1	DN2	Code
12mm	23	12	19	6	23	12	19	6	DN10	DN10	38667
15mm	28	15	23	8	28	15	23	8	DN12	DN12	38668

### S21SCP/7040 Obtuse street elbow

Press x male end for insertion into a fitting

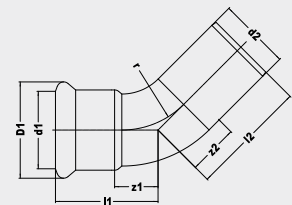

Size	l1	d1	D1	z1	l2	d2	z2	DN1	DN2	Code
12mm	23	12	19	6	32	12	15	DN10	DN10	38671
15mm	28	15	23	8	37	15	17	DN12	DN12	38672

### S22CP/7086 Partial crossover

Press x male end for insertion into an XPress fitting

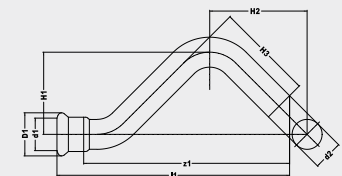

Size	l1	d1	D1	z1	l2	d2	z2	DN1	DN2	Code
15mm	110	15	23	90	15	23	50	DN12	DN12	38675

### S23CP/7085 Full crossover

Press x press

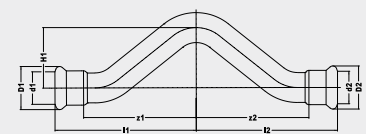

Size	l1	d1	D1	z1	l2	d2	D2	z2	DN1	DN2	Code
15mm	70	15	23	50	70	15	23	50	DN12	DN12	38677

# CHROMIUM PLATED PRESS FITTINGS FOR JOINTING CHROMIUM PLATED COPPER TUBE



### S24CP/7130 Equal tee

Press on all ends

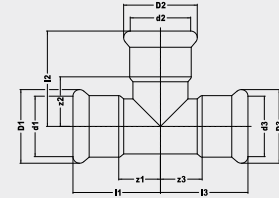
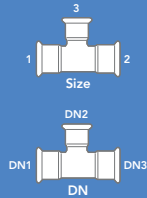

Size	l1	d1	D1	z1	l2	d2	D2	z2	l3	d3	D3	z3	DN1	DN2	DN3	Code
12mm	28	12	19	11	28	12	19	11	28	12	19	11	DN10	DN10	DN10	38710
15mm	32	15	23	12	32	15	23	12	32	15	23	12	DN12	DN12	DN12	38711
22mm	37	22	31	16	37	22	31	16	37	22	31	16	DN20	DN20	DN20	38712

### S25CP/7130 Tee, reduced branch

Press on all ends

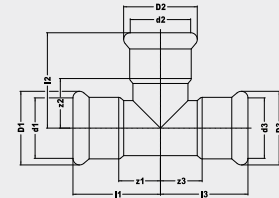
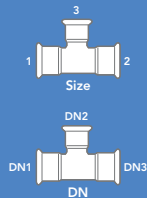

Size	l1	d1	D1	z1	l2	d2	D2	z2	l3	d3	D3	z3	DN1	DN2	DN3	Code
15 x 15 x 12mm	32	15	23	12	32	12	19	15	32	15	23	12	DN12	DN10	DN12	38714
22 x 22 x 15mm	37	22	31	16	38	15	23	18	37	22	31	16	DN20	DN12	DN20	38715

### S26CP/7130 Tee, one end reduced

Press on all ends

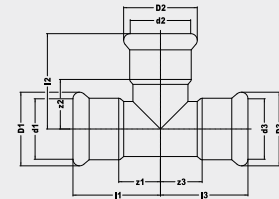
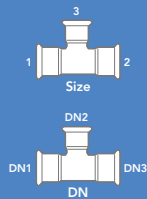

Size	l1	d1	D1	z1	l2	d2	D2	z2	l3	d3	D3	z3	DN1	DN2	DN3	Code
15 x 12 x 15mm	32	15	23	12	32	15	23	12	36	12	19	19	DN12	DN12	DN10	38719

### S27CP/7130 Tee, one end and branch reduced

Press on all ends

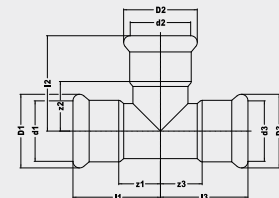
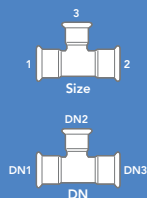

Size	l1	d1	D1	z1	l2	d2	D2	z2	l3	d3	D3	z3	DN1	DN2	DN3	Code
15 x 12 x 12mm	32	15	23	12	32	12	19	15	32	12	19	15	DN12	DN10	DN10	38723



### S30CP/6130G Female branch tee

Press x BSP parallel female thread

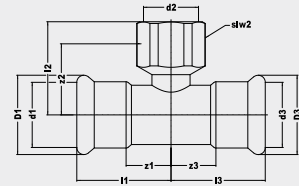
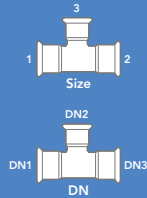

Size	l1	d1	D1	z1	l2	z2	slw2	sks2	l3	d3	D3	z3	DN1	DN2	DN3	Code
15 x 15mm x Rp1/2"	34	15	23	14	25	13	26	28	34	15	23	14	DN12	1/2" (DN15)	DN12	38733

### S61CP/7301 Stop end

Press for use with copper tube

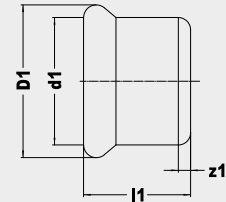

Size	l1	d1	D1	z1	DN1	Code
15mm	20	15	23	2	DN12	38739

### S68FFCP/6359 Flat faced union adaptor

Press x female union end

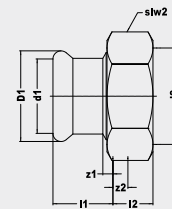

Size	l1	d1	D1	z1	slw1	sks1	l2	z2	slw2	sks2	DN1	DN2	Code
15mm x G3/4"	30	15	23	10	30	34	11	3	30	34	DN12	3/4" (DN20)	38742



Please visit the PY website for full dimensional data and drawings

### SS1 Straight coupling

Press x press

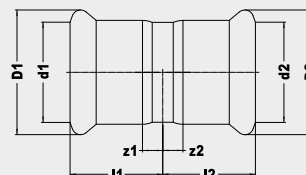

Size	l1	d1	D1	z1	l2	d2	D2	z2	DN1	DN2	Code
12mm	21	12	20	4	21	12	20	4	DN10	DN10	11530
15mm	25	15	23	5	25	15	23	5	DN12	DN12	11694
18mm	25	18	27	5	25	18	27	5	DN15	DN15	11695
22mm	26	22	32	5	26	22	32	5	DN20	DN20	11696
28mm	28	28	38	5	28	28	38	5	DN25	DN25	11697
35mm	31	35	45	5	31	35	45	5	DN32	DN32	11698
42mm	36	42	54	6	36	42	54	6	DN40	DN40	11699
54mm	41	54	65	6	41	54	65	6	DN50	DN50	11700
76.1mm	71	76	94	16	71	76	94	16	DN65	DN65	20415
88.9mm	82	89	109	19	82	89	109	19	DN80	DN80	20416
108mm	96	108	133	19	96	108	133	19	DN100	DN100	20417

### SS1FMF Female metric flange PN16

Press x steel flange to EN 1092-1:1997 (BS 4504)

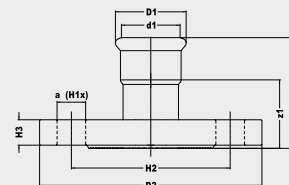

Size	l1	d1	D1	z1	D2	DN1	DN2	Code
22mm x DN20 (3/4")	59	22	32	38	105	DN20	DN20	11570
28mm x DN25 (1")	65	28	38	42	115	DN25	DN25	11571
35mm x DN32 (1 1/4")	69	35	45	43	140	DN32	DN32	11572
42mm x DN40 (1 1/2")	77	42	54	47	150	DN40	DN40	11680
54mm x DN50 (2")	87	54	65	52	165	DN50	DN50	11681
76.1mm x DN65 (2 1/2")	126	76	94	71	185	DN65	DN65	20412
88.9mm x DN80 (3")	147	89	109	84	200	DN80	DN80	20413
108mm x DN100 (4")	167	108	133	90	220	DN100	DN100	20414



## FEATURES

✚ Leak Before Press (LBP) technology identifies joints that have not been pressed correctly in sizes 15mm-54mm

✚ Designed for potable water applications where water quality and hygiene are crucial, particularly in the food, pharmaceutical and health care industries

✚ Heat-free jointing provides time and cost saving benefits to contractors/installers

### SS1Slip Straight coupling slip pattern

Press x press (without tube stop)

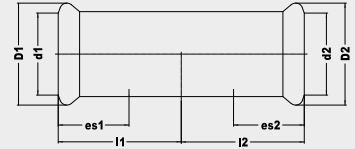

Size	l1	d1	D1	l2	d2	D2	DN1	DN2	Code
15mm	40	15	23	40	15	23	DN12	DN12	11728
18mm	40	18	27	40	18	27	DN15	DN15	11730
22mm	42	22	32	42	22	32	DN20	DN20	11729
28mm	46	28	38	46	28	38	DN25	DN25	11731
35mm	51	35	45	51	35	45	DN32	DN32	11732
42mm	60	42	54	60	42	54	DN40	DN40	11733
54mm	70	54	65	70	54	65	DN50	DN50	11734
76.1mm	115	76	94	115	76	94	DN65	DN65	20428
88.9mm	129	89	109	129	89	109	DN80	DN80	20429
108mm	153	108	133	152	108	133	DN100	DN100	20430

### SS1V Transition for grooved coupling

Press x groove

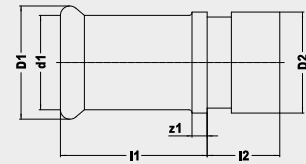

Size	l1	d1	D1	z1	l2	d2	DN1	DN2	Code
28 x 33.7mm	49	28	38	26	24	34	DN25	DN25	11675
35 x 42.4mm	54	35	45	28	24	42	DN32	DN40	11676
42 x 48.3mm	61	42	54	31	24	48	DN40	DN40	11677
54 x 60.3mm	73	54	65	38	24	60	DN50	DN50	11678
76.1 x 76.1mm	76	76	94	21	24	76	DN65	DN65	20461
88.9 x 88.9mm	86	89	109	23	24	89	DN80	DN80	20462
108 x 114mm	84	108	133	7	26	114	DN100	DN100	20463



### SS2 Straight female connector

Press x BSP parallel female thread

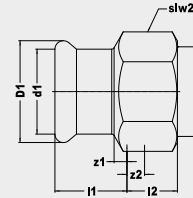

Size	l1	d1	D1	z1	l2	z2	slw2	sks2	DN1	DN2	Code
12mm x Rp3/8"	19	12	20	3	13	4	24	-	DN10	3/8" (DN10)	11531
12mm x Rp1/2"	19	12	20	2	15	4	24	-	DN10	1/2" (DN15)	11532
15mm x Rp1/2"	22	15	23	2	15	5	24	28	DN12	1/2" (DN15)	11641
18mm x Rp1/2"	22	18	26	2	15	5	27	31	DN15	1/2" (DN15)	11643
18mm x Rp3/4"	22	18	26	2	17	6	30	35	DN15	3/4" (DN20)	11644
22mm x Rp1/2"	21	22	32	3	15	7	32	37	DN20	1/2" (DN15)	11646
22mm x Rp3/4"	23	22	32	0	17	5	32	37	DN20	3/4" (DN20)	11647
22mm x Rp1"	24	22	32	2	20	6	38	44	DN20	1" (DN25)	11649
28mm x Rp1/2"	26	28	37	3	12	1	38	44	DN25	1/2" (DN15)	11631
28mm x Rp3/4"	23	28	37	0	17	6	38	38	DN25	3/4" (DN20)	11650
28mm x Rp1"	25	28	37	2	20	7	38	44	DN25	1" (DN25)	11648
28mm x Rp1 1/4"	25	28	37	2	22	7	46	53	DN25	1 1/4" (DN32)	11651
35mm x Rp1"	27	35	44	1	20	7	46	53	DN32	1" (DN25)	11652
35mm x Rp1 1/4"	28	35	44	2	22	8	46	53	DN32	1 1/4" (DN32)	11653
35mm x Rp1 1/2"	28	35	44	2	22	7	54	62	DN32	1 1/2" (DN40)	11632
42mm x Rp1 1/4"	30	42	54	2	22	8	54	62	DN40	1 1/4" (DN32)	11655
42mm x Rp1 1/2"	32	42	54	0	22	0	54	62	DN40	1 1/2" (DN40)	11654
54mm x Rp1 1/2"	36	54	65	1	22	8	67	77	DN50	1 1/2" (DN40)	11633
54mm x Rp2"	37	54	65	2	26	8	67	77	DN50	2" (DN50)	11657

### SS2LC Slip long connector

Press x BSP parallel female thread

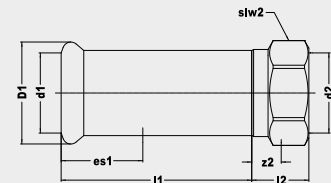

Size	l1	d1	D1	z1	l2	z2	slw2	sks2	DN1	DN2	Code
22mm x Rp1/2"	70	22	32	68	19	15	28	32	DN20	1/2" (DN15)	11590
22mm x Rp3/4"	70	22	32	73	24	17	32	37	DN20	3/4" (DN20)	11591
28mm x Rp1/2"	70	28	38	68	21	15	34	39	DN25	1/2" (DN15)	11592
28mm x Rp3/4"	70	28	38	68	21	17	34	39	DN25	3/4" (DN20)	11593



## SS3

### Straight male connector

Press x BSP taper male thread

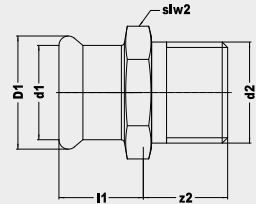

Size	l1	d1	D1	z2	slw2	sks2	DN1	DN2	Code
12mm x R1/2"	17	12	20	15	22	-	DN10	3/8" (DN10)	11533
12mm x R1/2"	17	12	20	18	24	-	DN10	1/2" (DN15)	11534
15mm x R1/2"	20	15	23	18	24	28	DN12	1/2" (DN15)	11658
18mm x R1/2"	20	18	27	18	27	31	DN15	1/2" (DN15)	11660
18mm x R3/4"	20	18	27	21	27	31	DN15	3/4" (DN20)	11661
22mm x R1/2"	21	22	32	21	32	37	DN20	1/2" (DN15)	11662
22mm x R3/4"	21	22	32	22	32	37	DN20	3/4" (DN20)	11664
22mm x R1"	21	22	32	28	34	39	DN20	1" (DN25)	11663
28mm x R3/4"	23	28	38	22	38	44	DN25	3/4" (DN20)	11642
28mm x R1"	23	28	38	25	38	44	DN25	1" (DN25)	11665
28mm x R1 1/4"	23	28	38	29	43	50	DN25	1 1/4" (DN32)	11666
35mm x R1"	26	35	45	27	54	52	DN32	1" (DN25)	11667
35mm x R1 1/4"	26	35	45	29	54	52	DN32	1 1/4" (DN32)	11670
35mm x R1 1/2"	26	35	45	30	49	57	DN32	1 1/2" (DN40)	11645
42mm x R1 1/4"	30	42	54	29	54	62	DN40	1 1/4" (DN32)	11668
42mm x R1 1/2"	30	42	54	29	54	62	DN40	1 1/2" (DN40)	11671
54mm x R1 1/2"	35	54	65	30	67	77	DN50	1 1/2" (DN40)	11656
54mm x R2"	35	54	65	34	67	77	DN50	2" (DN50)	11674
76.1mm x R2 1/2"	56	76	94	75	80	92	DN65	2 1/2" (DN65)	20458
88.9mm x R3"	63	89	109	74	95	109	DN80	3" (DN80)	20459



#### SS6 Reducer

Larger end male for insertion into a fitting x press

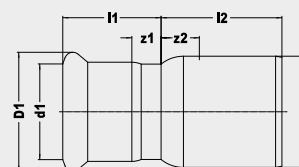

Size	l1	d1	D1	z1	l2	d2	z2	DN1	DN2	Code
15 x 12mm	23	12	20	6	27	15	7	DN10	DN12	11535
18 x 15mm	27	15	23	7	33	18	13	DN12	DN15	11712
22 x 15mm	28	15	23	8	33	22	12	DN12	DN20	11713
22 x 18mm	28	18	27	8	30	22	9	DN15	DN20	11714
28 x 15mm	28	15	23	8	40	28	17	DN12	DN25	11715
28 x 18mm	28	18	27	8	38	28	15	DN15	DN25	11716
28 x 22mm	29	22	32	8	34	28	11	DN20	DN25	11717
35 x 18mm	32	18	27	12	46	35	20	DN15	DN32	11718
35 x 22mm	29	22	32	8	42	35	16	DN20	DN32	11719
35 x 28mm	31	28	38	8	38	35	12	DN25	DN32	11720
42 x 22mm	33	22	32	12	53	42	23	DN20	DN40	11659
42 x 28mm	31	28	38	8	51	42	21	DN25	DN40	11722
42 x 35mm	34	35	45	8	42	42	12	DN32	DN40	11723
54 x 22mm	33	22	32	12	66	54	31	DN20	DN50	11724
54 x 28mm	34	28	38	11	62	54	27	DN25	DN50	11725
54 x 35mm	34	35	45	8	60	54	25	DN32	DN50	11726
54 x 42mm	40	42	54	10	55	54	20	DN40	DN50	11727
76.1 x 42mm	79	42	54	49	72	76	17	DN40	DN65	20460
76.1 x 54mm	42	54	65	7	98	76	43	DN50	DN65	20422
88.9 x 54mm	42	54	65	7	114	89	51	DN50	DN80	20423
88.9 x 76.1mm	68	76	94	13	88	89	25	DN65	DN80	20424
108 x 54mm	66	54	65	31	138	108	61	DN50	DN100	20425
108 x 76.1mm	69	76	94	14	127	108	50	DN65	DN100	20426
108 x 88.9mm	77	89	109	14	113	108	36	DN80	DN100	20427

#### SS12 Elbow

Press x press

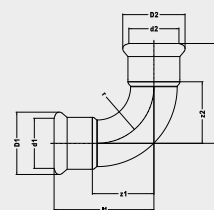

Size	l1	d1	D1	z1	l2	d2	D2	z2	DN1	DN2	Code
12mm	37	12	20	20	37	12	20	20	DN10	DN10	11536
15mm	41	15	23	21	41	15	23	21	DN12	DN12	11620
18mm	45	18	27	25	45	18	27	25	DN15	DN15	11621
22mm	51	22	32	30	51	22	32	30	DN20	DN20	11622



Size	l1	d1	D1	z1	l2	d2	D2	z2	DN1	DN2	Code
28mm	60	28	38	37	60	28	38	37	DN25	DN25	11623
35mm	71	35	45	45	71	35	45	45	DN32	DN32	11624
42mm	86	42	54	56	86	42	54	56	DN40	DN40	11625
54mm	105	54	65	70	105	54	65	70	DN50	DN50	11626
76.1mm	150	76	94	95	150	76	94	95	DN65	DN65	20406
88.9mm	174	89	109	111	174	89	109	111	DN80	DN80	20407
108mm	215	108	133	138	215	108	133	138	DN100	DN100	20408

### SS12S Street elbow

Press x male end for insertion into a fitting

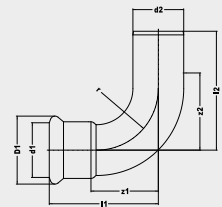

Size	l1	d1	D1	z1	l2	d2	z2	DN1	DN2	Code
12mm	37	12	20	20	48	12	31	DN10	DN10	11537
15mm	41	15	23	21	49	15	29	DN12	DN12	11634
18mm	45	18	27	25	51	18	31	DN15	DN15	11635
22mm	51	22	32	30	60	22	39	DN20	DN20	11636
28mm	60	28	38	37	66	28	43	DN25	DN25	11637
35mm	71	35	45	45	76	35	50	DN32	DN32	11638
42mm	86	42	54	56	93	42	63	DN40	DN40	11639
54mm	105	54	65	70	111	54	76	DN50	DN50	11640
76.1mm	150	76	94	95	165	76	110	DN65	DN65	20409
88.9mm	175	89	109	112	190	89	127	DN80	DN80	20410
108mm	216	108	133	139	238	108	161	DN100	DN100	20411

### SS13 Male elbow

Press x BSP taper male thread

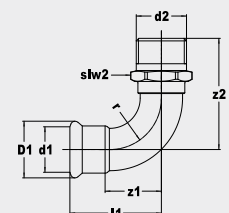

Size	l1	d1	D1	z1	l2	z2	slw2	sks2	DN1	DN2	Code
15mm x R1/2"	43	15	23	23	31	31	22	25	DN12	1/2" (DN15)	11687
18mm x R1/2"	44	18	27	24	32	32	24	28	DN15	1/2" (DN15)	11688
22mm x R3/4"	49	22	32	28	39	39	30	35	DN20	3/4" (DN20)	11689
28mm x R1"	53	28	38	30	46	46	34	39	DN25	1" (DN25)	11690
35mm x R1 1/4"	60	35	45	34	52	52	43	50	DN32	1 1/4" (DN32)	11691
42mm x R1 1/2"	69	42	54	39	58	58	49	57	DN40	1 1/2" (DN40)	11692
54mm x R2"	82	54	65	47	68	68	62	72	DN50	2" (DN50)	11693



### SS14 Female elbow

Press x BSP parallel female thread

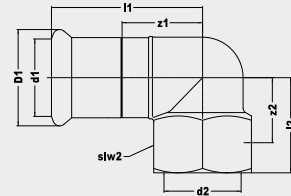

Size	l1	d1	D1	z1	l2	z2	slw2	sks2	DN1	DN2	Code
15mm x Rp1/2"	44	15	23	24	28	13	24	28	DN12	1/2" (DN15)	11682
22mm x Rp1/2"	45	22	32	24	31	16	24	28	DN20	1/2" (DN15)	11683
22mm x Rp3/4"	49	22	32	28	33	17	30	35	DN20	3/4" (DN20)	11684
28mm x Rp1/2"	48	28	38	25	35	20	24	28	DN25	1/2" (DN15)	11600
28mm x Rp3/4"	51	28	38	28	35	19	30	35	DN25	3/4" (DN20)	11601
28mm x Rp1"	55	28	38	32	37	24	38	44	DN25	1" (DN25)	11685
35mm x Rp1/2"	56	35	45	30	35	20	24	28	DN32	1/2" (DN15)	11602
35mm x Rp3/4"	58	35	45	32	37	21	30	35	DN32	3/4" (DN20)	11603
35mm x Rp1"	58	35	45	32	41	28	38	44	DN32	1" (DN25)	11669
35mm x Rp1 1/4"	62	35	45	36	42	27	46	53	DN32	1 1/4" (DN32)	11686

### SS15L Female backplate elbow

Press x BSP parallel female thread

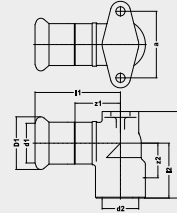

Size	l1	d1	D1	z1	l2	z2	DN1	DN2	Code
15mm x 1/2"	45	15	23	25	28	13	DN12	1/2" (DN15)	11708
18mm x 1/2"	45	18	27	25	28	13	DN15	1/2" (DN15)	11709
22mm x 3/4"	49	22	32	28	33	17	DN20	3/4" (DN20)	11710

### SS19S 15° bend

Male x male

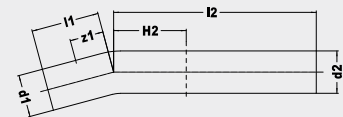
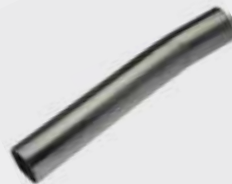

Size	l1	d1	z1	l2	d2	DN1	DN2	Code
28mm	45	28	22	134	28	DN25	DN25	11550
35mm	73	35	47	222	35	DN32	DN32	11551
42mm	89	42	59	280	42	DN40	DN40	11552
54mm	122	54	87	337	54	DN50	DN50	11553



### SS19S 30° bend

Male x male

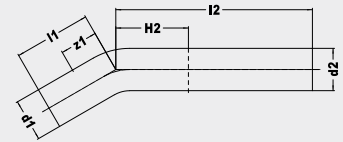

Size	l1	d1	z1	l2	d2	DN1	DN2	Code
28mm	51	28	28	130	28	DN25	DN25	11554
35mm	73	35	47	214	35	DN32	DN32	11795
42mm	99	42	69	272	42	DN40	DN40	11796
54mm	134	54	99	326	54	DN50	DN50	11797

### SS19S 60° bend

Male x male

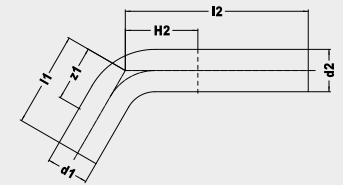

Size	l1	d1	z1	l2	d2	DN1	DN2	Code
28mm	63	28	40	121	28	DN25	DN25	11555
35mm	97	35	71	203	35	DN32	DN32	11556
42mm	102	42	72	256	42	DN40	DN40	11557
54mm	162	54	127	306	54	DN50	DN50	11558

### SS19S 90° bend

Male x male

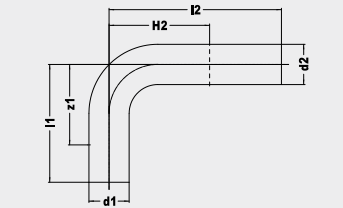

Size	l1	d1	z1	l2	d2	DN1	DN2	Code
22mm	72	22	51	120	22	DN20	DN20	11561
28mm	82	28	59	120	28	DN25	DN25	11562
35mm	120	35	94	200	35	DN32	DN32	11563
42mm	150	42	120	250	42	DN40	DN40	11564
54mm	200	54	165	300	54	DN50	DN50	11565



#### SS21 Obtuse elbow

Press x press

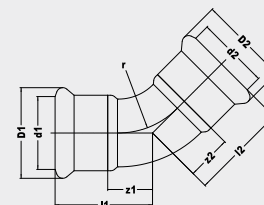

Size	l1	d1	D1	z1	l2	d2	D2	z2	DN1	DN2	Code
15mm	31	15	23	11	31	15	23	31	DN12	DN12	11604
18mm	32	18	27	12	32	18	27	32	DN15	DN15	11605
22mm	35	22	32	14	35	22	32	35	DN20	DN20	11606
28mm	40	28	38	17	40	28	38	40	DN25	DN25	11607
35mm	47	35	45	21	47	35	45	47	DN32	DN32	11608
42mm	56	42	54	26	56	42	54	56	DN40	DN40	11609
54mm	67	54	65	32	67	54	65	67	DN50	DN50	11610
76.1mm	98	76	94	43	98	76	94	43	DN65	DN65	20400
88.9mm	112	89	109	49	112	89	109	49	DN80	DN80	20401
108mm	138	108	133	61	138	108	133	61	DN100	DN100	20402

#### SS21S Obtuse street elbow

Press x male end for insertion into a fitting

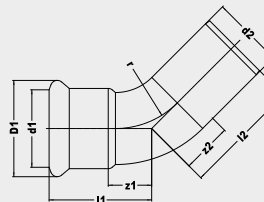

Size	l1	d1	D1	z1	l2	d2	z2	DN1	DN2	Code
15mm	30	15	23	10	38	15	18	DN12	DN12	11611
18mm	32	18	27	12	39	18	19	DN15	DN15	11612
22mm	35	22	32	14	42	22	21	DN20	DN20	11613
28mm	40	28	38	17	46	28	23	DN25	DN25	11614
35mm	46	35	45	20	51	35	25	DN32	DN32	11615
42mm	56	42	54	36	63	42	33	DN40	DN40	11616
54mm	65	54	65	30	73	54	38	DN50	DN50	11617
76.1mm	98	76	94	43	117	76	62	DN65	DN65	20403
88.9mm	112	89	109	49	131	89	68	DN80	DN80	20404
108mm	138	108	133	61	154	108	77	DN100	DN100	20405



### SS225 Crossover

Male x male

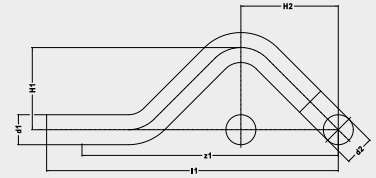

Size	l1	d1	z1	d2	DN1	DN2	Code
22mm	178	22	157	22	DN20	DN20	11618
28mm	210	28	187	28	DN25	DN25	11619

### SS24 Equal tee

Press on all ends

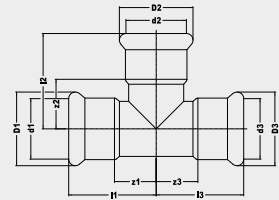
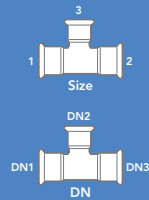

Size	l1	d1	D1	z1	l2	d2	D2	z2	l3	d3	D3	z3	DN1	DN2	DN3	Code
12mm	28	12	20	17	32	12	20	17	28	12	20	17	DN10	DN10	DN10	11538
15mm	35	15	23	15	39	15	23	19	35	15	23	15	DN12	DN12	DN12	11735
18mm	35	15	23	15	39	15	23	19	35	15	23	15	DN12	DN12	DN12	11737
22mm	40	22	32	19	44	22	32	23	40	22	32	19	DN20	DN20	DN20	11740
28mm	45	28	38	22	49	28	38	26	45	28	38	22	DN25	DN25	DN25	11744
35mm	51	35	45	25	55	35	45	29	51	35	45	25	DN32	DN32	DN32	11749
42mm	60	42	54	30	62	42	54	32	60	42	54	30	DN40	DN40	DN40	11753
54mm	71	54	65	36	72	54	65	37	71	54	65	36	DN50	DN50	DN50	11758
76.1mm	116	76	94	116	116	76	94	116	116	76	94	116	DN65	DN65	DN65	20431
88.9mm	231	89	109	231	231	89	109	231	231	89	95	231	DN80	DN80	DN80	20432
108mm	156	108	133	156	156	108	133	156	156	108	133	156	DN100	DN100	DN100	20433



### SS25 Tee, reduced branch

Press on all ends

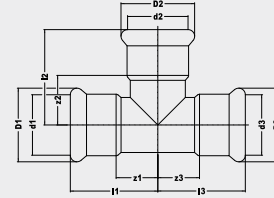
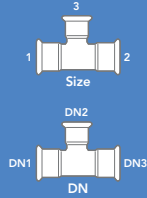

Size	l1	d1	D1	z1	l2	d2	D2	z2	l3	d3	D3	z3	DN1	DN2	DN3	Code
18 x 18 x 15mm	37	18	27	17	40	15	23	21	37	18	27	17	DN15	DN12	DN15	11736
22 x 22 x 15mm	40	22	32	19	43	15	23	23	40	22	32	19	DN20	DN12	DN20	11738
22 x 22 x 18mm	40	28	38	17	43	18	27	23	40	28	38	17	DN25	DN15	DN25	11739
28 x 28 x 15mm	45	28	38	22	46	15	23	26	45	28	38	22	DN25	DN12	DN25	11741
28 x 28 x 18mm	45	28	38	22	46	18	27	26	45	28	38	22	DN25	DN15	DN25	11742
28 x 28 x 22mm	45	28	38	22	47	22	32	26	45	28	38	22	DN25	DN20	DN25	11743
35 x 35 x 15mm	51	35	45	25	49	15	23	29	51	35	45	25	DN32	DN12	DN32	11745
35 x 35 x 18mm	51	35	45	25	49	18	27	29	51	35	45	25	DN32	DN15	DN32	11746
35 x 35 x 22mm	51	35	45	25	50	22	32	29	51	35	45	25	DN32	DN20	DN32	11747
35 x 35 x 28mm	51	35	45	25	52	28	38	29	51	35	45	25	DN32	DN25	DN32	11748
42 x 42 x 22mm	60	42	54	30	53	22	32	32	60	42	54	30	DN40	DN20	DN40	11750
42 x 42 x 28mm	60	42	54	30	55	28	38	32	60	42	54	30	DN40	DN25	DN40	11751
42 x 42 x 35mm	60	42	54	30	58	35	45	32	60	42	54	30	DN40	DN32	DN40	11752
54 x 54 x 22mm	71	54	65	36	59	22	32	38	71	54	65	36	DN50	DN20	DN50	11754
54 x 54 x 28mm	71	54	65	36	61	28	38	38	71	54	65	36	DN50	DN25	DN50	11755
54 x 54 x 35mm	71	54	65	36	64	35	45	38	71	54	65	36	DN50	DN32	DN50	11756
54 x 54 x 42mm	71	54	65	36	58	42	54	28	71	54	65	36	DN50	DN40	DN50	11757
76.1 x 76.1 x 22mm	116	76	94	61	68	22	32	45	116	76	94	61	DN65	DN20	DN65	20434
76.1 x 76.1 x 28mm	116	76	94	61	71	28	38	74	116	76	94	61	DN65	DN25	DN65	20435
76.1 x 76.1 x 35mm	116	76	94	61	75	35	45	48	116	76	94	61	DN65	DN32	DN65	20436
76.1 x 76.1 x 42mm	116	76	94	61	79	42	54	47	116	76	94	61	DN65	DN40	DN65	20437
76.1 x 76.1 x 54mm	116	76	94	61	80	54	65	43	116	76	94	61	DN65	DN50	DN65	20438
88.9 x 88.9 x 22mm	131	89	109	68	76	22	32	53	131	89	95	68	DN80	DN20	DN80	20439
88.9 x 88.9 x 28mm	131	89	109	68	76	28	38	52	131	89	95	68	DN80	DN25	DN80	20440
88.9 x 88.9 x 35mm	131	89	109	68	83	35	45	56	131	89	95	68	DN80	DN32	DN80	20441
88.9 x 88.9 x 42mm	131	89	109	68	85	42	54	53	131	89	95	68	DN80	DN40	DN80	20442
88.9 x 88.9 x 54mm	131	89	109	68	93	54	65	56	131	89	95	68	DN80	DN50	DN80	20443
88.9 x 88.9 x 76.1mm	131	89	109	68	116	76	94	61	131	89	95	68	DN80	DN65	DN80	20444
108 x 108 x 22mm	156	108	133	79	85	22	32	62	156	108	133	79	DN100	DN20	DN100	20445
108 x 108 x 28mm	156	108	133	79	88	28	38	64	156	108	133	79	DN100	DN25	DN100	20446
108 x 108 x 35mm	156	108	133	79	94	35	45	67	156	108	133	79	DN100	DN32	DN100	20447
108 x 108 x 42mm	156	108	133	79	96	42	54	64	156	108	133	79	DN100	DN40	DN100	20448
108 x 108 x 54mm	156	108	133	79	102	54	65	65	156	108	133	79	DN100	DN50	DN100	20449
108 x 108 x 76.1mm	156	108	133	79	125	76	94	70	156	108	133	79	DN100	DN65	DN100	20450
108 x 108 x 88.9mm	156	108	133	79	135	89	109	72	156	108	133	79	DN100	DN80	DN100	20451



## SS30 Female branch tee

Press x BSP parallel female branch

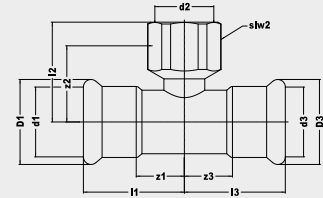
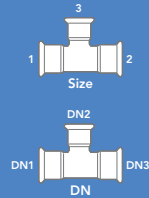

Size	l1	d1	D1	z1	l2	z2	slw2	sks2	l3	d3	D3	z3	DN1	DN2	DN3	Code
15 x 15mm x Rp1/2"	35	15	23	15	34	24	24	28	35	15	23	15	DN12	1/2" (DN15)	DN12	11759
18 x 18mm x Rp1/2"	37	18	27	17	35	25	24	28	37	18	27	17	DN15	1/2" (DN15)	DN15	11760
18 x 18mm x Rp3/4"	37	18	27	17	37	26	30	35	37	18	27	17	DN15	3/4" (DN20)	DN15	11761
22 x 22mm x Rp1/2"	40	22	32	19	37	27	24	28	40	22	32	19	DN20	1/2" (DN15)	DN20	11762
22 x 22mm x Rp3/4"	40	22	32	19	39	28	30	35	40	22	32	19	DN20	3/4" (DN20)	DN20	11763
28 x 28mm x Rp1/2"	45	28	38	22	40	30	24	28	45	28	38	22	DN25	1/2" (DN15)	DN25	11765
28 x 28mm x Rp3/4"	45	28	38	22	42	31	30	35	45	28	38	22	DN25	3/4" (DN20)	DN25	11766
28 x 28mm x Rp1"	45	28	38	22	46	33	38	44	45	28	38	22	DN25	1" (DN25)	DN25	11627
35 x 35mm x Rp1/2"	51	35	45	25	44	34	24	28	51	35	45	25	DN32	1/2" (DN15)	DN32	11767
35 x 35mm x Rp3/4"	51	35	45	25	46	35	30	35	51	35	45	25	DN32	3/4" (DN20)	DN32	11768
35 x 35mm x Rp1"	51	35	45	25	50	37	38	44	51	35	45	25	DN32	1" (DN25)	DN32	11628
42 x 42mm x Rp1/2"	60	42	54	30	46	36	24	28	60	42	54	30	DN40	1/2" (DN15)	DN40	11769
42 x 42mm x Rp3/4"	60	42	54	30	48	37	30	35	60	42	54	30	DN40	3/4" (DN20)	DN40	11770
42 x 42mm x Rp1"	60	42	54	30	52	39	38	44	60	42	54	30	DN40	1" (DN25)	DN40	11629
54 x 54mm x Rp1/2"	71	54	65	36	52	42	24	28	71	54	65	36	DN50	1/2" (DN15)	DN50	11771
54 x 54mm x Rp3/4"	71	54	65	36	54	43	30	35	71	54	65	36	DN50	3/4" (DN20)	DN50	11773
54 x 54mm x Rp1"	71	54	65	36	58	45	38	44	71	54	65	36	DN50	1" (DN25)	DN50	11630
54 x 54mm x Rp2"	71	54	65	36	65	47	67	77	71	54	65	36	DN50	2" (DN50)	DN50	11772
76.1 x 76.1mm x Rp3/4"	116	76	94	61	68	55	30	35	116	76	94	61	DN65	3/4" (DN20)	DN65	20452
76.1 x 76.1mm x Rp2"	116	76	94	61	81	59	65	75	116	76	94	61	DN65	2" (DN50)	DN65	20453
88.9 x 88.9mm x Rp3/4"	131	89	109	68	87	74	30	35	131	89	95	68	DN80	3/4" (DN20)	DN80	20454
88.9 x 88.9mm x Rp2"	131	89	109	68	88	66	65	75	131	89	96	68	DN80	2" (DN50)	DN80	20455
108 x 108mm x Rp3/4"	156	108	133	79	86	73	30	35	156	108	134	79	DN100	3/4" (DN20)	DN100	20456
108 x 108mm x Rp2"	156	108	133	79	98	76	65	75	156	108	134	79	DN100	2" (DN50)	DN100	20457



#### SS61 Stop end

Press, for use on stainless steel tube

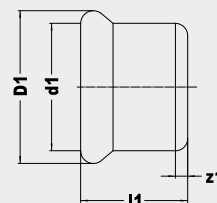

Size	l1	d1	D1	z1	DN1	Code
15mm	23	15	23	3	DN12	11701
18mm	23	18	27	3	DN15	11702
22mm	24	22	32	3	DN20	11703
28mm	26	28	38	3	DN25	11704
35mm	29	35	45	3	DN32	11705
42mm	37	42	54	7	DN40	11706
54mm	42	54	65	7	DN50	11707
76.1mm	95	76	94	40	DN65	20418
88.9mm	107	89	109	44	DN80	20419
108mm	127	108	133	50	DN100	20420

#### SS68FF Flat faced union adaptor

Press x BSP female union end

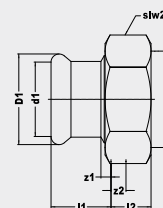

Size	l1	d1	D1	z1	l2	z2	slw2	sks2	DN1	DN2	Code
22mm x G1"	30	22	32	9	10	2	37	43	DN20	1" (DN25)	11891
28mm x G1 1/4"	31	28	38	8	10	2	46	53	DN25	1 1/4" (DN32)	11892
35mm x G1 1/2"	34	35	45	8	11	2	52	60	DN32	1 1/2" (DN40)	11893
42mm x G1 3/4"	41	42	54	11	11	2	58	67	DN40	1 3/4" (DN40)	11894
54mm x G2 3/8"	47	54	65	12	11	3	75	87	DN50	2 3/8" (DN50)	11895



## SS69

### Straight male union connector

Press x BSP taper male thread

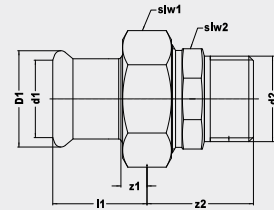

Size	l1	d1	D1	z1	slw1	sks1	l2	z2	slw2	sks2	DN1	DN2	Code
15mm x R1/2"	29	15	23	9	30	35	33	33	25	29	DN12	1/2" (DN15)	11774
18mm x R1/2"	29	18	26	9	30	35	33	33	25	29	DN15	1/2" (DN15)	11776
22mm x R1/2"	30	22	32	9	37	43	33	33	25	29	DN20	1/2" (DN15)	11721
22mm x R3/4"	30	22	32	9	37	43	29	29	32	37	DN20	3/4" (DN20)	11779
22mm x R1"	30	22	32	9	37	43	42	42	39	45	DN20	1" (DN25)	11764
28mm x R1"	31	28	37	8	46	53	42	42	39	45	DN25	1" (DN25)	11781
35mm x R1 1/4"	34	35	44	8	52	60	44	44	49	57	DN32	1 1/4" (DN32)	11782
42mm x R1 1/2"	41	42	54	11	58	67	44	44	51	59	DN40	1 1/2" (DN40)	11783
54mm x R2"	47	54	65	12	75	87	53	53	65	75	DN50	2" (DN50)	11784

## SS69F

### Straight female union connector

Press x BSP parallel female thread

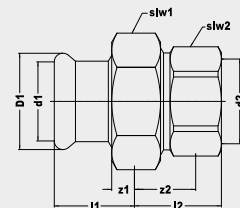

Size	l1	d1	D1	z1	slw1	sks1	l2	z2	slw2	sks2	DN1	DN2	Code
15mm x Rp1/2"	29	15	23	9	30	35	28	18	24	28	DN12	1/2" (DN15)	11785
18mm x Rp1/2"	29	18	26	9	30	35	28	18	24	28	DN15	1/2" (DN15)	11787
22mm x Rp3/4"	30	22	32	9	37	43	33	22	30	35	DN20	3/4" (DN20)	11789
22mm x Rp1"	30	22	32	9	37	43	36	23	38	44	DN20	1" (DN25)	11798
28mm x Rp1"	31	28	37	8	46	53	34	21	38	44	DN25	1" (DN25)	11791
35mm x Rp1 1/4"	34	35	44	8	52	60	39	24	46	53	DN32	1 1/4" (DN32)	11792
42mm x Rp1 1/2"	41	42	54	11	58	67	41	27	54	62	DN40	1 1/2" (DN40)	11793
54mm x Rp2"	47	54	65	12	75	87	44	26	67	77	DN50	2" (DN50)	11794



#### SS75 Expansion axial compensator

Press x press

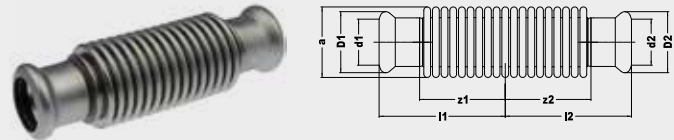

Size	l1	d1	D1	z1	l2	d2	D2	z2	DN1	DN2	Code
15mm	55	15	24	35	55	15	23	35	DN12	DN12	11540
18mm	53	18	27	33	53	18	27	33	DN15	DN15	11541
22mm	60	22	32	39	60	22	32	39	DN20	DN20	11542
28mm	65	28	38	42	65	28	38	42	DN25	DN25	11543
35mm	70	35	45	44	70	35	45	44	DN32	DN32	11544
42mm	77	42	54	47	77	42	54	47	DN40	DN40	11545
54mm	90	54	65	55	90	54	65	55	DN50	DN50	11546

#### SS76 Expansion axial compensator

Drum ends

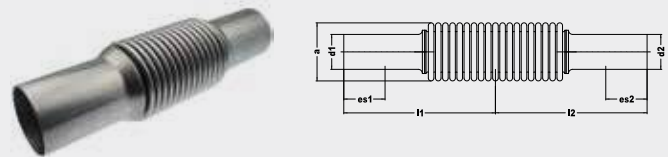

Size	l1	d1	z1	l2	d2	z2	DN1	DN2	Code
76.1mm	145	76	90	145	76	90	DN65	DN65	20465
88.9mm	173	89	110	173	89	110	DN80	DN80	20466
108mm	138	108	61	138	108	61	DN100	DN100	20467

#### SS80 Straight flexible hose

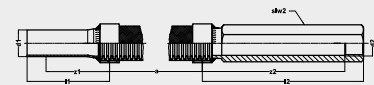

Size	l1	d1	z1	l2	z2	slw2	sks2	DN1	DN2	Code
22 x 1000mm	60	22	39	125	110	27	31	DN20	1/2" (DN15)	11575
22 x 1500mm	60	22	39	125	110	27	31	DN20	1/2" (DN15)	11576
22 x 2000mm	60	22	39	125	110	27	31	DN20	1/2" (DN15)	11577
28 x 1000mm	68	28	45	125	110	27	31	DN25	1/2" (DN15)	11578
28 x 1500mm	68	28	45	125	110	27	31	DN25	1/2" (DN15)	11579
28 x 2000mm	68	28	45	125	110	27	31	DN25	1/2" (DN15)	11580



Key: HWG = Heating, Potable Water and Gas applications  
 HWG+S = All of the above plus XPress Stainless Sprinkler System



### SS82 Bent flexible hose

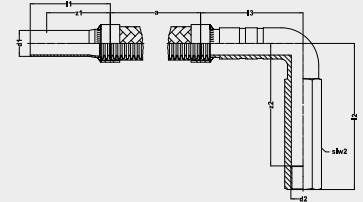

Size	l1	d1	z1	l2	z2	slw2	sks2	l3	DN1	DN2	Code
22 x 800mm	60	22	39	145	130	27	31	79	DN20	1/2" (DN15)	11581
22 x 1000mm	60	22	39	145	130	27	31	79	DN20	1/2" (DN15)	11582
22 x 1500mm	60	22	39	145	130	27	31	79	DN20	1/2" (DN15)	11583
28 x 800mm	68	28	45	145	130	27	31	79	DN25	1/2" (DN15)	11584
28 x 1000mm	68	28	45	145	130	27	31	79	DN25	1/2" (DN15)	11585
28 x 1500mm	68	28	45	145	130	27	31	79	DN25	1/2" (DN15)	11586

### SS600 Stainless steel 316 HWG+S tube

1.4401

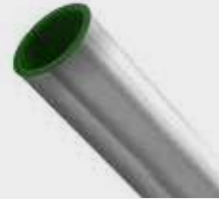

Size	d1	DN1	Code
15 x 1.0mm x 6.0m	15	DN12	25050
18 x 1.0mm x 6.0m	18	DN15	25051
22 x 1.2mm x 6.0m	22	DN20	25052
28 x 1.2mm x 6.0m	28	DN25	25053
35 x 1.5mm x 6.0m	35	DN32	25054
42 x 1.5mm x 6.0m	42	DN40	25055
54 x 1.5mm x 6.0m	54	DN50	25056

### SS610 Stainless steel 316 HWG tube

1.4401

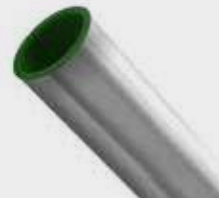

Size	d1	DN1	Code
15 x 0.6mm x 6.0m	15	DN12	25010
18 x 0.7mm x 6.0m	18	DN15	25001
22 x 0.7mm x 6.0m	22	DN20	25002
28 x 0.8mm x 6.0m	28	DN25	25016
35 x 1.0mm x 6.0m	35	DN32	25018
42 x 1.1mm x 6.0m	42	DN40	25019
54 x 1.2mm x 6.0m	54	DN50	25021



#### SS620 Stainless steel 316 HWG+S tube

1.4401



Size	d1	DN1	Code
76.1 x 2.0mm x 6.0m	76	DN65	25026
88.9 x 2.0mm x 6.0m	89	DN80	25028
108 x 2.0mm x 6.0m	108	DN100	25030

#### SS630 Stainless steel 444 sprinkler tube

1.4521

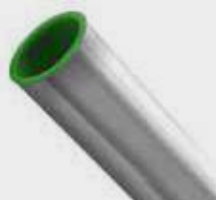

Size	d1	DN1	Code
22 x 1.2mm x 6.0m	22	DN20	25072
28 x 1.2mm x 6.0m	28	DN25	25073
35 x 1.5mm x 6.0m	35	DN32	25074
42 x 1.5mm x 6.0m	42	DN40	25075
54 x 1.5mm x 6.0m	54	DN50	25076

#### SS640 Stainless steel 439 sprinkler tube

1.4520



Size	d1	DN1	Code
22 x 1.2mm x 6.0m	22	DN20	25067
28 x 1.2mm x 6.0m	28	DN25	25068
35 x 1.5mm x 6.0m	35	DN32	25069
42 x 1.5mm x 6.0m	42	DN40	25070
54 x 1.5mm x 6.0m	54	DN50	25071

## 2.0 PRODUCT DETAILS

# LBP CARBON STEEL PRESS JOINTING SYSTEM



### SC1 Straight coupling

Press x press

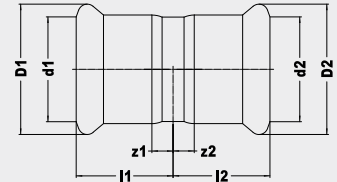

Size	l1	d1	D1	z1	l2	d2	D2	z2	DN1	DN2	Code
12mm	24	12	20	7	24	12	20	7	DN10	DN10	20560
15mm	27	15	23	7	27	15	23	7	DN12	DN12	20136
18mm	27	18	27	7	27	18	27	7	DN15	DN15	20137
22mm	28	22	32	7	28	22	32	7	DN20	DN20	20138
28mm	30	28	38	7	29	28	38	7	DN25	DN25	20139
35mm	33	35	45	7	33	35	45	7	DN32	DN32	20140
42mm	38	42	54	8	38	42	54	8	DN40	DN40	20141
54mm	43	54	65	8	43	54	65	8	DN50	DN50	20142
66.7mm	60	67	83	10	60	67	83	10	DN65	DN65	20662
76.1mm	63	76	95	8	63	76	95	8	DN65	DN65	20620
88.9mm	72	89	110	9	72	89	110	9	DN80	DN80	20621
108mm	86	108	133	9	86	108	133	9	DN100	DN100	20622

### SC1FMF Female metric flange PN16

Press x steel flange to EN 1092-1:1997 (BS 4504)

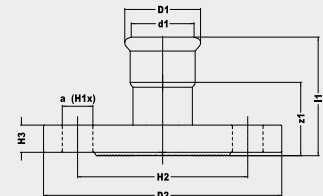

Size	l1	d1	D1	z1	D2	DN1	DN2	Code
35mm x DN32	70	35	45	44	140	DN32	DN32	20562
42mm x DN40	77	42	54	47	150	DN40	DN40	20563
54mm x DN50	87	54	65	52	165	DN50	DN50	20564
66.7mm x DN65 (2 1/2")	89	67	83	39	185	DN65	DN65	20685
76.1mm x DN65 (2 1/2")	112	76	95	57	185	DN65	DN65	20659
88.9mm x DN80 (3")	118	89	110	55	200	DN80	DN80	20660
108mm x DN65 (4")	114	108	133	37	220	DN100	DN100	20661



### SC1FMF6 Female metric flange PN6

Press x steel flange to EN 1092-1:1997 (BS 4504)

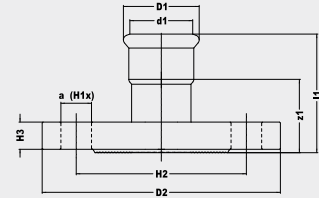

Size	l1	d1	D1	z1	D2	DN1	DN2	Code
35mm x DN32	70	35	45	44	140	DN32	DN32	20562
42mm x DN40	77	42	54	47	150	DN40	DN40	20563
54mm x DN50	87	54	65	52	165	DN50	DN50	20564
66.7mm x DN65 (2 1/2")	89	67	83	39	185	DN65	DN65	20734
76.1mm x DN65 (2 1/2")	112	76	95	57	185	DN65	DN65	20735
88.9mm x DN80 (3")	118	89	110	55	200	DN80	DN80	20736
108mm x DN65 (4")	114	108	133	37	220	DN100	DN100	20737

### SC1 Slip Straight coupling slip pattern

Press x press (without tube stop)

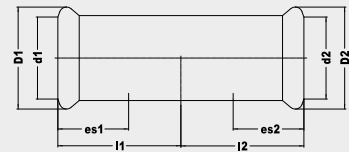

Size	l1	d1	D1	l2	d2	D2	DN1	DN2	Code
12mm	34	12	20	34	12	20	DN10	DN10	20561
15mm	40	15	23	40	15	23	DN12	DN12	20144
18mm	40	18	27	40	18	27	DN15	DN15	20145
22mm	42	22	32	42	22	32	DN20	DN20	20146
28mm	46	28	38	46	28	38	DN25	DN25	20147
35mm	52	35	45	52	35	45	DN32	DN32	20148
42mm	61	42	54	61	42	54	DN40	DN40	20149
54mm	70	54	65	70	54	65	DN50	DN50	20150
66.7mm	99	67	83	99	67	83	DN65	DN65	20663
76.1mm	115	76	95	115	76	95	DN65	DN65	20623
88.9mm	131	89	110	131	89	110	DN80	DN80	20624
108mm	151	108	133	151	108	133	DN100	DN100	20625

### SC1R Straight reduced coupling

Press x press

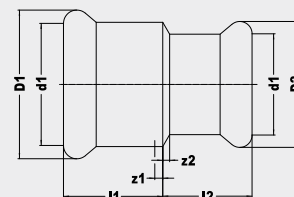

Size	l1	d1	D1	z1	l2	d2	D2	z2	DN1	DN2	Code
28 x 22mm	25	28	37	2	23	22	32	2	DN25	DN20	20154

## FEATURES

✚ Leak Before Press (LBP) technology identifies joints that have not been pressed correctly in sizes 15mm-54mm

✚ Designed for vented and unvented closed circuit heating and chilled water applications

✚ Heat-free jointing provides time and cost saving benefits to contractors/installers

### SC1V Transition for grooved coupling

Press x groove

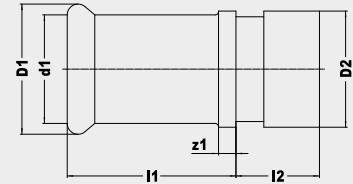

Size	l1	d1	D1	z1	l2	d2	DN1	DN2	Code
28 x 33.7mm	49	28	38	26	24	34	DN25	DN25	20187
35 x 42.4mm	54	35	45	28	24	42	DN32	DN40	20188
42 x 48.3mm	61	42	54	31	24	48	DN40	DN40	20189
54 x 60.3mm	73	54	65	38	24	60	DN50	DN50	20190
76.1 x 76.1mm	56	76	95	1	24	76	DN65	DN65	20731
88.9 x 88.9mm	76	89	110	13	24	89	DN80	DN780	20732
108 x 114mm	84	108	133	7	26	114	DN100	DN100	20733

### SC2 Straight female connector

Press x BSP parallel female thread

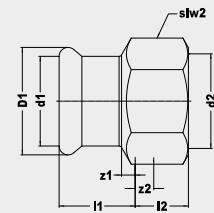

Size	l1	d1	D1	z1	l2	z2	slw2	sks2	DN1	DN2	Code
12mm x Rp1/2"	20	12	20	3	19	4	24	28	DN10	1/2" (DN15)	20565
15mm x Rp1/2"	22	15	23	2	19	4	24	28	DN12	1/2" (DN15)	20237
18mm x Rp1/2"	21	18	26	1	19	4	27	31	DN15	1/2" (DN15)	20238
18mm x Rp3/4"	23	18	26	3	20	4	30	35	DN15	3/4" (DN20)	20239
22mm x Rp1/2"	22	22	32	1	14	0	32	37	DN20	1/2" (DN15)	20245
22mm x Rp3/4"	23	22	32	2	20	4	32	37	DN20	3/4" (DN20)	20240
28mm x Rp1/2"	24	28	37	1	14	1	41	47	DN25	1/2" (DN15)	20244
28mm x Rp3/4"	24	28	38	1	17	0	38	44	DN25	3/4" (DN20)	20246
28mm x Rp1"	26	28	37	3	23	4	41	47	DN25	1" (DN25)	20241
35mm x Rp1/2"	30	35	44	4	12	1	46	53	DN32	1/2" (DN15)	20365
35mm x Rp3/4"	28	35	44	2	15	3	46	53	DN32	3/4" (DN20)	20366
35mm x Rp1"	33	35	44	7	13	0	46	53	DN32	1" (DN25)	20367
35mm x Rp1 1/4"	28	35	44	2	22	7	46	53	DN32	1 1/4" (DN32)	20247
42mm x Rp1 1/2"	32	42	54	2	22	6	54	62	DN40	1 1/2" (DN40)	20209
54mm x Rp2"	37	54	65	2	26	8	67	77	DN50	2" (DN50)	20210



### SC2LC Slip long connector

Press x BSP parallel female thread

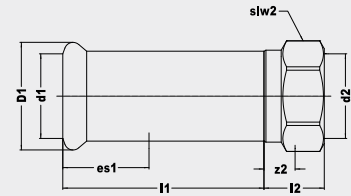

Size	l1	d1	D1	z1	l2	z2	slw2	sks2	DN1	DN2	Code
22mm x Rp1/2"	92	22	32	71	22	15	28	32	DN20	1/2" (DN15)	20323
22mm x Rp3/4"	97	22	32	76	27	17	32	37	DN20	3/4" (DN20)	20324
28mm x Rp1/2"	94	28	38	71	24	15	32	37	DN25	1/2" (DN15)	20325
28mm x Rp3/4"	93	28	38	70	23	17	32	37	DN25	3/4" (DN20)	20326

### SC3 Straight male connector

Press x BSP taper male thread

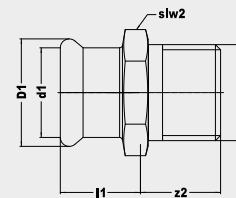

Size	l1	d1	D1	z2	slw2	sks2	DN1	DN2	Code
12mm x R3/8"	17	12	20	14	22	25	DN10	3/8" (DN10)	20566
15mm x R3/8"	20	15	23	15	24	28	DN12	3/8" (DN10)	20227
15mm x R1/2"	20	15	23	19	24	28	DN12	1/2" (DN15)	20228
18mm x R1/2"	20	18	27	19	27	31	DN15	1/2" (DN15)	20229
18mm x R3/4"	20	18	27	20	27	31	DN15	3/4" (DN20)	20230
22mm x R1/2"	21	22	32	22	32	37	DN20	1/2" (DN15)	20242
22mm x R3/4"	21	22	32	23	32	37	DN20	3/4" (DN20)	20231
22mm x R1"	21	22	32	29	34	39	DN20	1" (DN25)	20243
28mm x R3/4"	23	28	38	23	38	44	DN25	3/4" (DN20)	20236
28mm x R1"	23	28	38	25	41	47	DN25	1" (DN25)	20232
35mm x R1"	26	35	45	27	46	53	DN32	1" (DN25)	20567
35mm x R1 1/4"	26	35	45	29	46	53	DN32	1 1/4" (DN32)	20233
42mm x R1 1/2"	30	42	54	29	56	64	DN40	1 1/2" (DN40)	20234
54mm x R2"	35	54	65	34	70	81	DN50	2" (DN50)	20235
66.7mm x R2 1/2"	50	67	83	40	85	98	DN65	2 1/2" (DN65)	20664
76.1mm x R2 1/2"	55	76	95	64	80	92	DN65	2 1/2" (DN65)	20713
88.9mm x R3"	63	89	110	69	95	110	DN80	3" (DN80)	20714



## SC6 Reducer

Large male end for insertion into a fitting x press

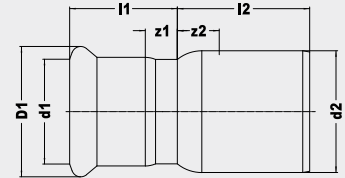

Size	l1	d1	D1	z1	l2	d2	z2	DN1	DN2	Code
15 x 12mm	29	12	20	12	27	15	7	DN10	DN12	20568
18 x 12mm	27	12	20	10	29	18	9	DN10	DN15	20569
22 x 12mm	27	12	20	10	33	22	12	DN10	DN20	20570
54 x 18mm	34	18	27	14	64	54	29	DN15	DN50	20571
18 x 15mm	31	15	23	11	27	18	7	DN12	DN15	20213
22 x 15mm	29	15	23	9	32	22	11	DN12	DN20	20215
22 x 18mm	32	18	27	12	29	22	8	DN15	DN20	20216
28 x 15mm	30	15	23	10	38	28	15	DN12	DN25	20217
28 x 18mm	30	18	27	10	36	28	13	DN15	DN25	20218
28 x 22mm	33	22	32	12	33	28	10	DN20	DN25	20219
35 x 22mm	30	22	32	9	41	35	15	DN20	DN32	20220
35 x 28mm	36	28	38	13	34	35	8	DN25	DN32	20221
42 x 22mm	32	22	32	11	51	42	21	DN20	DN40	20248
42 x 28mm	32	28	38	9	51	54	16	DN25	DN50	20212
42 x 35mm	39	35	45	13	41	42	11	DN32	DN40	20222
54 x 22mm	34	22	32	13	63	54	28	DN20	DN50	20223
54 x 28mm	33	28	38	10	58	54	23	DN25	DN50	20224
54 x 35mm	38	35	45	12	57	54	22	DN32	DN50	20226
54 x 42mm	44	42	54	14	52	54	17	DN40	DN50	20225
66.7 x 28mm	41	28	38	18	96	67	46	DN25	DN65	20665
66.7 x 35mm	38	35	45	12	84	67	34	DN32	DN65	20666
66.7 x 42mm	44	42	54	14	81	67	31	DN40	DN65	20667
66.7 x 54mm	48	54	65	13	72	67	22	DN50	DN65	20668
76.1 x 42mm	50	42	54	20	97	76	42	DN40	DN65	20715
76.1 x 54mm	55	54	65	20	86	76	31	DN50	DN65	20639
76.1 x 66.7mm	64	67	83	14	75	76	20	DN65	DN65	20669
88.9 x 54mm	54	54	65	19	101	89	38	DN50	DN80	20640
88.9 x 66.7mm	65	67	83	15	92	76	29	DN65	DN65	20670
88.9 x 76.1mm	68	76	95	13	90	89	27	DN65	DN80	20641
108 x 66.7mm	65	67	83	15	122	89	45	DN65	DN80	20671
108 x 76.1mm	68	76	95	13	120	108	43	DN65	DN100	20642
108 x 88.9mm	77	89	110	14	110	108	33	DN80	DN100	20643



### SC7 Female adaptor

Male end for insertion into a fitting x BSP parallel female thread

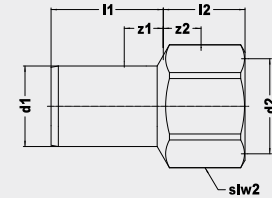

Size	l1	d1	z1	l2	z2	slw2	sks2	DN1	DN2	Code
12mm x Rp3/8"	25	12	8	17	6	19	-	DN10	3/8" (DN10)	20572
12mm x Rp1/2"	25	12	8	24	9	24	-	DN10	1/2" (DN15)	20573
15mm x Rp1/2"	28	15	8	23	8	24	-	DN12	1/2" (DN15)	20574
12mm x Rp1/2"	28	18	8	22	7	24	-	DN15	1/2" (DN15)	20575
12mm x Rp1/2"	28	18	8	25	9	30	-	DN15	3/4" (DN20)	20576
22mm x Rp1/2"	29	22	8	21	6	24	28	DN20	1/2" (DN15)	20256
22mm x Rp3/4"	29	22	8	24	8	30	35	DN20	3/4" (DN20)	20257

### SC12 Elbow

Press x press

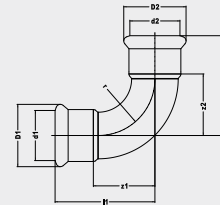

Size	l1	d1	D1	z1	l2	d2	D2	z2	DN1	DN2	Code
12mm	35	12	20	18	35	12	20	18	DN10	DN10	20577
15mm	41	15	23	21	41	15	23	21	DN12	DN12	20155
18mm	45	18	27	25	45	18	27	25	DN15	DN15	20156
22mm	51	22	32	30	51	22	32	30	DN20	DN20	20157
28mm	61	28	38	38	61	28	38	38	DN25	DN25	20158
35mm	72	35	45	46	72	35	45	46	DN32	DN32	20159
42mm	87	42	54	57	87	42	54	57	DN40	DN40	20160
54mm	105	54	65	70	105	54	65	70	DN50	DN50	20161
66.7mm	145	67	83	95	145	67	83	95	DN65	DN65	20672
76.1mm	155	76	95	100	155	76	95	100	DN65	DN65	20626
88.9mm	179	89	110	116	179	89	110	116	DN80	DN80	20627
108mm	216	108	133	139	216	108	133	139	DN100	DN100	20628



## SC12S Street elbow

Press x male end for insertion into a fitting

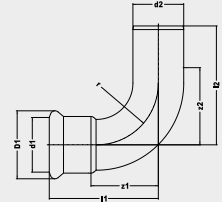

Size	l1	d1	D1	z1	l2	d2	z2	DN1	DN2	Code
12mm	35	12	20	18	42	12	25	DN10	DN10	20578
15mm	41	15	23	21	49	15	29	DN12	DN12	20163
18mm	45	18	27	25	51	18	31	DN15	DN15	20164
22mm	51	22	32	30	58	22	37	DN20	DN20	20165
28mm	61	28	38	38	66	28	43	DN25	DN25	20166
35mm	72	35	45	46	76	35	50	DN32	DN32	20167
42mm	87	42	54	57	93	42	63	DN40	DN40	20168
54mm	105	54	65	70	111	54	74	DN50	DN50	20169
66.7mm	145	67	83	95	157	67	107	DN65	DN65	20673
76.1mm	155	76	95	100	168	76	113	DN65	DN65	20629
88.9mm	179	89	110	116	193	89	130	DN80	DN80	20630
108mm	216	108	133	139	233	108	156	DN100	DN100	20631

## SC13 Male elbow

Press x male BSP taper thread

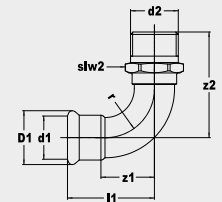

Size	l1	d1	D1	z1	l2	z2	slw2	sks2	DN1	DN2	Code
12mm x R3/8"	35	12	20	18	42	42	17	20	DN10	3/8" (DN10)	20579
15mm x R3/8"	41	15	24	21	45	45	19	22	DN12	3/8" (DN10)	20198
15mm x R1/2"	41	15	24	21	50	50	22	25	DN12	1/2" (DN15)	20199
18mm x R1/2"	45	18	27	25	54	54	22	25	DN15	1/2" (DN15)	20200
22mm x R3/4"	51	22	32	30	62	62	30	35	DN20	3/4" (DN20)	20201
28mm x R1"	61	28	38	38	74	74	36	42	DN25	1" (DN25)	20202
35mm x R1 1/4"	72	35	45	46	86	86	46	53	DN32	1 1/4" (DN32)	20206
42mm x R1 1/2"	87	42	54	57	96	96	50	58	DN40	1 1/2" (DN40)	20204
54mm x R2"	105	54	65	70	116	116	60	69	DN50	2" (DN50)	20205



#### SC13A Angle adaptor

Press x male BSP taper thread

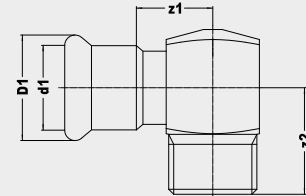

Size	l1	d1	D1	z1	l2	z2	slw2	sks2	DN1	DN2	Code
18mm x Rp1/2"	42	18	27	22	28	28	22	26	DN15	1/2" (DN15)	20207
22mm x Rp3/4"	45	22	32	24	32	32	28	33	DN20	3/4" (DN20)	20208

#### SC14 Elbow

Press x male BSP taper thread

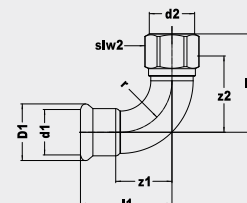

Size	l1	d1	D1	z1	l2	z2	slw2	sks2	DN1	DN2	Code
15mm x Rp3/8"	41	15	23	21	42	31	19	-	DN12	3/8" (DN10)	20580
15mm x Rp1/2"	41	15	23	21	48	33	24	-	DN12	1/2" (DN15)	20581
18mm x Rp1/2"	45	18	27	25	52	37	24	-	DN15	1/2" (DN15)	20582
22mm x Rp1/2"	51	22	32	30	59	44	27	31	DN20	1/2" (DN15)	20345
22mm x Rp3/4"	51	22	32	30	29	43	30	35	DN20	3/4" (DN20)	20346
28mm x Rp1/2"	61	28	38	38	65	50	32	37	DN25	1/2" (DN15)	20347
28mm x Rp3/4"	61	28	38	38	65	49	32	37	DN25	3/4" (DN20)	20348
28mm x Rp1"	61	28	38	38	70	51	41	47	DN25	1" (DN25)	20349
35mm x Rp1/2"	72	35	45	46	75	55	41	47	DN32	1/2" (DN15)	20350
35mm x Rp3/4"	72	35	45	46	75	54	41	47	DN32	3/4" (DN20)	20351
35mm x Rp1"	72	35	45	46	75	56	41	47	DN32	1" (DN25)	20352

#### SC14A Angle adaptor

Press x female BSP pal thread

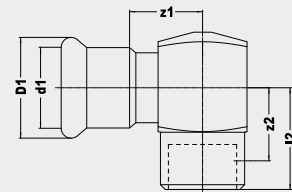

Size	l1	d1	D1	z1	l2	z2	slw2	sks2	DN1	DN2	Code
22mm x Rp1/2"	45	22	32	24	31	16	28	32	DN20	1/2" (DN15)	20355
28mm x Rp1/2"	51	28	38	28	35	20	36	42	DN25	1/2" (DN15)	20356
35mm x Rp1/2"	57	35	45	31	35	20	42	49	DN32	1/2" (DN15)	20357



## SC19S Elbow male x male

Both ends male for insertion into a fitting

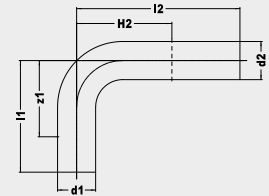

Size	l1	d1	z1	l2	d2	DN1	DN2	Code
12mm	72	12	55	122	12	DN10	DN10	20583
15mm	72	15	52	122	15	DN12	DN12	20584
18mm	72	18	52	122	18	DN15	DN15	20585
22mm	74	22	53	122	22	DN20	DN20	20370
28mm	84	28	61	122	28	DN25	DN25	20371
35mm	122	35	96	202	35	DN32	DN32	20372
42mm	152	42	122	252	42	DN40	DN40	20373
54mm	202	54	167	302	54	DN50	DN50	20374

## SC21 Obtuse elbow

Press x press

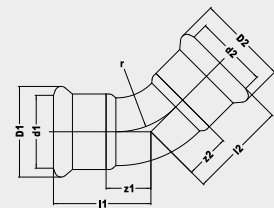

Size	l1	d1	D1	z1	l2	d2	D2	z2	DN1	DN2	Code
15mm	31	15	23	11	31	15	23	11	DN12	DN12	20170
18mm	32	18	27	12	32	18	27	12	DN15	DN15	20171
22mm	35	22	32	14	35	22	32	14	DN20	DN20	20172
28mm	40	28	38	17	40	28	38	17	DN25	DN25	20173
35mm	46	35	45	20	46	35	45	20	DN32	DN32	20174
42mm	56	42	54	26	56	42	54	26	DN40	DN40	20175
54mm	67	54	65	32	67	54	65	31	DN50	DN50	20176
66.7mm	98	67	83	48	98	67	83	48	DN65	DN65	20674
76.1mm	101	76	95	46	101	76	95	46	DN65	DN65	20632
88.9mm	116	89	110	53	116	89	110	53	DN80	DN80	20633
108mm	139	108	133	62	139	108	133	62	DN100	DN100	20634



### SC215 Obtuse street elbow

Press x male end for insertion into a fitting

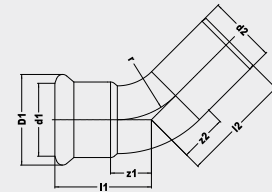

Size	l1	d1	D1	z1	l2	d2	z2	DN1	DN2	Code
15mm	31	15	23	11	38	15	18	DN12	DN12	20177
18mm	32	18	27	12	39	18	19	DN15	DN15	20178
22mm	35	22	32	14	42	22	21	DN20	DN20	20179
28mm	40	28	38	17	46	28	23	DN25	DN25	20180
35mm	46	35	45	20	51	35	25	DN32	DN32	20181
42mm	56	42	54	26	63	42	33	DN40	DN40	20182
54mm	67	54	65	32	73	54	38	DN50	DN50	20183
66.7mm	98	67	83	48	110	67	60	DN65	DN65	20675
76.1mm	101	76	95	46	114	76	59	DN65	DN65	20635
88.9mm	116	89	110	53	130	89	67	DN80	DN80	20636
108mm	139	108	133	62	157	108	80	DN100	DN100	20637

### SC225 Partial crossover

Both ends male for insertion into a fitting

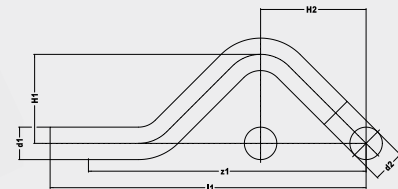

Size	l1	d1	z1	d2	DN1	DN2	Code
12mm	154	12	137	12	DN10	DN10	20586
15mm	158	15	138	15	DN12	DN12	20193
18mm	165	18	145	18	DN15	DN15	20194
22mm	178	22	157	22	DN20	DN20	20195
28mm	210	28	187	28	DN25	DN25	20196

### SC24 Equal tee

Press on all ends

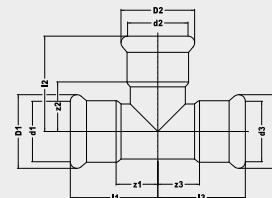
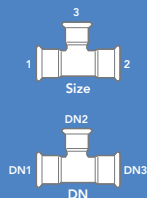

Size	l1	d1	D1	z1	l2	d2	D2	z2	l3	d3	D3	z3	DN1	DN2	DN3	Code
12mm	31	12	20	14	40	12	20	23	31	12	20	14	DN10	DN10	DN10	20587
15mm	35	15	23	15	44	15	23	24	35	15	23	15	DN12	DN12	DN12	20249
18mm	37	18	27	17	46	18	27	26	37	18	27	17	DN15	DN15	DN15	20250
22mm	40	22	32	19	49	22	32	28	40	22	32	19	DN20	DN20	DN20	20251



Size	l1	d1	D1	z1	l2	d2	D2	z2	l3	d3	D3	z3	DN1	DN2	DN3	Code
28mm	45	28	38	22	54	28	38	31	45	28	38	22	DN25	DN25	DN25	20252
35mm	52	35	45	26	60	35	45	34	52	35	45	26	DN32	DN32	DN32	20253
42mm	61	42	54	31	67	42	54	37	61	42	54	31	DN40	DN40	DN40	20254
54mm	71	54	65	36	78	54	65	43	71	54	65	36	DN50	DN50	DN50	20255
66.7mm	99	67	83	49	101	67	83	51	99	67	83	49	DN65	DN65	DN65	20676
76.1mm	115	76	95	60	110	76	95	55	115	76	95	60	DN65	DN65	DN65	20644
88.9mm	130	89	110	67	128	89	110	65	130	89	110	67	DN80	DN80	DN80	20645
108mm	155	108	133	78	153	108	133	76	155	108	133	78	DN100	DN100	DN100	20646

**SC25**  
**Tee, reduced branch**  
 Press on all ends

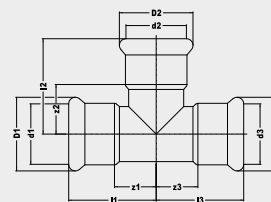
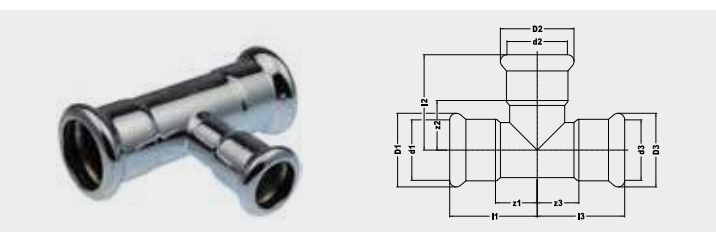

Size	l1	d1	D1	z1	l2	d2	D2	z2	l3	d3	D3	z3	DN1	DN2	DN3	Code
15 x 15 x 12mm	35	15	23	15	41	12	20	21	35	15	23	35	DN12	DN10	DN12	20588
18 x 18x 12mm	37	18	27	17	43	12	20	26	37	18	27	37	DN15	DN10	DN15	20589
22 x 22 x 12mm	40	22	32	19	45	12	20	24	40	22	32	40	DN20	DN10	DN20	20590
18 x 18 x 15mm	37	18	27	17	46	15	23	29	37	18	27	17	DN15	DN10	DN15	20258
22 x 22 x 15mm	40	22	32	19	48	15	23	27	40	22	32	19	DN20	DN20	DN20	20260
22 x 22 x 18mm	40	22	32	19	48	18	27	27	40	22	32	19	DN20	DN20	DN20	20261
28 x 28 x 15mm	45	28	38	22	51	15	23	31	45	28	38	22	DN25	DN12	DN25	20262
28 x 28 x 18mm	45	28	38	22	51	18	27	31	45	28	38	22	DN25	DN15	DN25	20263
28 x 28 x 22mm	45	28	38	22	52	22	32	31	45	28	38	22	DN25	DN20	DN25	20264
35 x 35 x 15mm	52	35	45	26	54	15	23	34	52	35	45	26	DN32	DN12	DN32	20265
35 x 35 x 18mm	52	35	45	26	54	18	27	34	52	35	45	26	DN32	DN15	DN32	20266
35 x 35 x 22mm	52	35	45	26	55	22	32	34	52	35	45	26	DN32	DN20	DN32	20267
35 x 35 x 28mm	52	35	45	26	57	28	38	34	52	35	45	26	DN32	DN25	DN32	20268
42 x 42 x 22mm	60	42	54	30	58	22	32	37	60	42	54	30	DN40	DN20	DN40	20269
42 x 42 x 28mm	60	42	54	30	60	28	38	37	60	42	54	30	DN40	DN25	DN40	20270
42 x 42 x 35mm	60	42	54	30	63	35	45	37	60	42	54	30	DN40	DN32	DN40	20271
54 x 54 x 22mm	71	54	65	36	64	22	32	43	71	54	65	36	DN50	DN20	DN50	20272
54 x 54 x 28mm	71	54	65	36	66	28	38	43	71	54	65	36	DN50	DN25	DN50	20273
54 x 54 x 35mm	71	54	65	36	69	35	45	43	71	54	65	36	DN50	DN32	DN50	20274
54 x 54 x 42mm	71	54	65	36	73	42	54	43	71	54	65	36	DN50	DN40	DN50	20275
66.7 x 66.7 x 28mm	99	67	83	49	70	28	38	47	99	67	83	49	DN65	DN25	DN65	20677
66.7 x 66.7 x 35mm	99	67	83	49	74	35	45	48	99	67	83	49	DN65	DN32	DN65	20678
66.7 x 66.7 x 42mm	99	67	83	49	80	42	54	50	99	67	83	49	DN65	DN40	DN65	20679
66.7 x 66.7 x 54mm	99	67	830	49	83	54	65	48	99	67	83	49	DN65	DN50	DN65	20680
76.1 x 76.1 x 22mm	115	76	95	60	68	22	32	47	115	76	95	60	DN65	DN20	DN65	20686
76.1 x 76.1 x 28mm	115	76	95	60	85	28	38	62	115	76	95	60	DN65	DN25	DN65	20687



Size	l1	d1	D1	z1	l2	d2	D2	z2	l3	d3	D3	z3	DN1	DN2	DN3	Code
76.1 x 76.1 x 35mm	115	76	95	60	87	35	45	61	115	76	95	60	DN65	DN32	DN65	20688
76.1 x 76.1 x 42mm	115	76	95	60	97	42	54	67	115	76	95	60	DN65	DN40	DN65	20689
76.1 x 76.1 x 54mm	115	76	95	60	110	54	65	75	115	76	95	60	DN65	DN50	DN65	20647
76.1 x 76.1 x 66.7mm	126	76	95	71	105	67	83	55	126	76	95	71	DN65	DN65	DN65	20681
88.9 x 88.9 x 22mm	130	89	110	67	76	22	32	55	130	89	110	67	DN80	DN20	DN80	20690
88.9 x 88.9 x 28mm	130	89	110	67	92	28	38	69	130	89	110	67	DN80	DN25	DN80	20691
88.9 x 88.9 x 35mm	130	89	110	67	97	35	45	71	130	89	110	67	DN80	DN32	DN80	20692
88.9 x 88.9 x 42mm	130	89	110	67	105	42	54	75	130	89	110	67	DN80	DN40	DN80	20693
88.9 x 88.9 x 54mm	130	89	110	67	117	54	65	82	130	89	110	67	DN80	DN50	DN80	20694
88.9 x 88.9 x 66.7mm	128	89	110	65	112	67	83	62	128	89	110	65	DN80	DN65	DN80	20682
88.9 x 88.9 x 76.1mm	130	89	110	67	117	76	95	62	130	89	110	67	DN80	DN65	DN80	20648
108 x 108 x 22mm	155	108	133	78	85	22	32	64	155	108	133	78	DN100	DN20	DN100	20695
108 x 108 x 28mm	155	108	133	78	102	28	38	79	155	108	133	78	DN100	DN25	DN100	20696
108 x 108 x 35mm	155	108	133	78	107	35	45	81	155	108	133	78	DN100	DN32	DN100	20697
108 x 108 x 42mm	155	108	133	78	115	42	54	85	155	108	133	78	DN100	DN40	DN100	20698
108 x 108 x 54mm	155	108	133	78	128	54	65	93	155	108	133	78	DN100	DN50	DN100	20699
108 x 108 x 76.1mm	155	108	133	78	128	76	95	73	155	108	133	78	DN100	DN65	DN100	20700
108 x 108 x 88.9mm	155	108	133	78	137	89	110	82	155	108	133	78	DN100	DN65	DN100	20649

### SC28 Tee, both ends reduced

Press on all ends

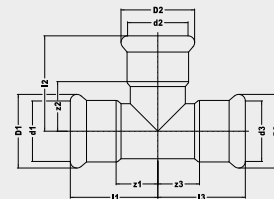
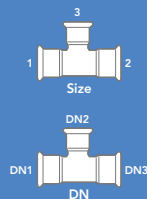

Size	l1	d1	D1	z1	l2	d2	D2	z2	l3	d3	D3	z3	DN1	DN2	DN3	Code
12 x 12 x 15mm	31	12	20	14	43	15	23	23	31	12	20	14	DN10	DN12	DN10	20591
15 x 15 x 18mm	35	15	23	15	44	18	27	24	35	15	23	15	DN12	DN15	DN12	20709
15 x 15 x 22mm	35	15	23	15	48	22	32	27	35	15	23	15	DN12	DN20	DN12	20710
22 x 22 x 28mm	40	22	32	19	52	28	38	29	40	22	32	19	DN20	DN25	DN20	20712



## SC30 Female branch tee

Press x BSP parallel female branch

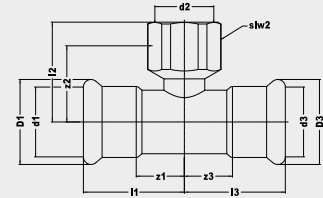
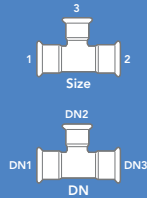

Size	l1	d1	D1	z1	l2	z2	slw2	sks2	l3	d3	D3	z3	DN1	DN2	DN3	Code
18 x 18mm x Rp3/4"	37	18	27	24	17	24	30	35	37	18	27	24	DN15	3/4" (DN20)	DN15	20592
15 x 15mm x Rp1/2"	35	15	23	15	37	22	24	28	35	15	23	15	DN12	1/2" (DN15)	DN12	20281
18 x 18mm x Rp1/2"	37	18	27	17	37	22	24	28	37	18	27	17	DN15	1/2" (DN15)	DN15	20282
22 x 22mm x Rp1/2"	40	22	32	19	39	24	24	28	40	22	32	19	DN20	1/2" (DN15)	DN20	20283
22 x 22mm x Rp3/4"	40	22	32	19	41	25	30	35	40	22	32	19	DN20	3/4" (DN20)	DN20	20288
28 x 28mm x Rp1/2"	45	28	38	22	42	27	24	28	45	28	38	22	DN25	1/2" (DN15)	DN25	20284
28 x 28mm x Rp3/4"	45	28	38	22	44	28	30	35	45	28	38	22	DN25	3/4" (DN20)	DN25	20289
28 x 28mm x Rp1"	45	28	38	22	48	25	41	47	45	28	38	22	DN25	1" (DN25)	DN25	20279
35 x 35mm x Rp1/2"	52	35	45	26	46	31	24	28	52	35	45	26	DN32	1/2" (DN15)	DN32	20285
35 x 35mm x Rp3/4"	52	35	45	26	48	31	30	35	52	35	45	26	DN32	3/4" (DN20)	DN32	20290
35 x 35mm x Rp1"	52	35	45	26	52	29	41	47	52	35	45	26	DN32	1" (DN25)	DN32	20280
42 x 42mm x Rp1/2"	61	42	54	31	48	33	24	28	61	42	54	31	DN40	1/2" (DN15)	DN40	20286
42 x 42mm x Rp3/4"	61	42	54	31	50	34	30	35	61	42	54	31	DN40	3/4" (DN20)	DN40	20291
42 x 42mm x Rp1"	61	42	54	31	54	31	41	47	61	42	54	31	DN40	1" (DN25)	DN40	20294
54 x 54mm x Rp1/2"	71	54	65	36	54	39	24	28	71	54	65	36	DN50	1/2" (DN15)	DN50	20287
54 x 54mm x Rp3/4"	71	54	65	36	56	40	30	35	71	54	65	36	DN50	3/4" (DN20)	DN50	20292
54 x 54mm x Rp1"	71	54	65	36	60	37	41	47	71	54	65	36	DN50	1" (DN25)	DN50	20293
66.7 x 66.7mm x Rp3/4"	99	67	83	49	65	62	30	35	99	67	83	49	DN65	3/4" (DN20)	DN65	20683
76.1 x 76.1mm x Rp3/4"	115	76	95	60	82	66	30	35	115	76	95	60	DN65	3/4" (DN20)	DN65	20650
88.9 x 88.9mm x Rp3/4"	130	89	110	67	84	68	30	35	130	89	110	67	DN80	3/4" (DN20)	DN80	20651
108 x 108mm x Rp3/4"	155	108	133	78	94	78	30	35	155	108	133	78	DN100	3/4" (DN20)	DN100	20652

## SC50 Cross press all ends

Press on all ends

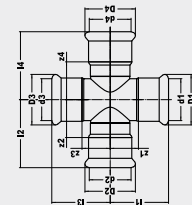
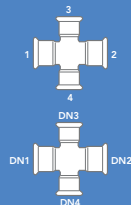

Size	l1	d1	D1	z1	l2	d2	D2	z2	l3	d3	D3	z3	l4	d4	D4	z4	DN1	DN2	DN3	DN4	Code
35mm	52	35	45	26	60	35	45	34	52	35	45	26	60	35	45	26	DN32	DN32	DN32	DN32	20327
42mm	61	42	54	31	67	42	54	37	61	42	54	31	67	42	54	31	DN40	DN40	DN40	DN40	20328
54mm	71	54	65	36	78	54	65	43	71	54	65	36	78	54	65	36	DN50	DN50	DN50	DN50	20329
35 x 28 x 35 x 28mm	52	35	45	26	57	28	38	34	52	35	45	26	57	28	38	34	DN32	DN25	DN32	DN25	20334
42 x 28 x 42 x 28mm	61	42	54	32	60	28	38	37	61	42	54	31	60	28	38	37	DN40	DN25	DN40	DN25	20335
54 x 28 x 54 x 28mm	71	54	65	36	66	28	38	43	71	54	65	36	66	28	38	43	DN50	DN25	DN50	DN25	20336



### SC51 Pass press fit all ends

Press on all ends

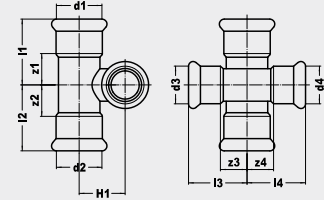

Size	l1/l3	d1/d3	D1/D3	z1/z3	l2/l4	d2/d4	D2/D4	z2/z4	H	DN1	DN2	DN3	DN4	Code
15mm	35	15	23	15	35	15	23	15	21	DN12	DN12	DN12	DN12	20593
18 x 15mm	37	18	27	17	35	15	23	15	23	DN15	DN12	DN15	DN12	20594
22 x 15mm	40	22	15	19	35	15	23	15	25	DN20	DN12	DN20	DN12	20595
22 x 18mm	40	22	18	19	37	18	27	17	26	DN20	DN15	DN20	DN15	20596
28 x 15mm	45	28	15	22	35	15	23	15	28	DN25	DN12	DN25	DN12	20597
28 x 18mm	45	28	18	22	37	18	27	17	29	DN25	DN15	DN25	DN15	20598
28 x 22mm	45	28	38	22	40	22	32	19	31	DN25	DN20	DN25	DN20	20333

### SC61 Stop end

Press for use on carbon steel tube

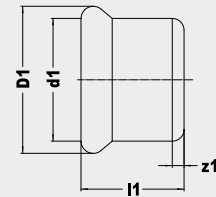

Size	l1	d1	D1	z1	DN1	Code
15mm	23	15	23	3	DN12	20295
18mm	23	18	27	3	DN15	20296
22mm	24	22	32	3	DN20	20297
28mm	26	28	38	3	DN25	20298
35mm	29	35	45	3	DN32	20299
42mm	37	42	54	7	DN40	20300
54mm	42	54	65	7	DN50	20301
66.7mm	60	67	83	10	DN65	20684
76.1mm	64	76	95	9	DN65	20656
88.9mm	72	89	110	9	DN80	20657
108mm	97	108	133	20	DN100	20658

### SC68FF Half union press x BSP female union end

Press BSP female union end

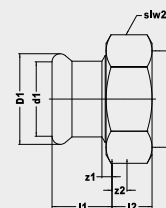

Size	l1	d1	D1	z1	l2	z2	slw2	sks2	DN1	DN2	Code
15 x G3/4"	29	15	23	9	8	2	30	-	DN12	3/4" (DN20)	20599
18 x G3/4"	29	18	27	9	8	2	30	-	DN15	3/4" (DN20)	20600



Size	l1	d1	D1	z1	l2	z2	slw2	sks2	DN1	DN2	Code
22mm x G1"	30	22	32	9	10	2	36	42	DN20	1" (DN25)	20337
28mm x G1 1/4"	31	28	38	8	10	2	46	53	DN25	1 1/4" (DN32)	20338
35mm x G1 1/2"	34	35	45	8	11	2	52	60	DN32	1 1/2" (DN40)	20339
42mm x G1 3/4"	41	42	54	11	11	2	52	60	DN40	1 3/4" (DN40)	20340
54mm x G2 3/8"	47	54	65	12	11	3	75	87	DN50	2 3/8" (DN50)	20341

### SC69 Straight male union connector

Press x BSP taper male thread

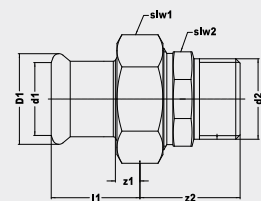

Size	l1	d1	D1	z1	slw1	sks1	l2	z2	slw2	sks2	DN1	DN2	Code
15mm x R1/2"	29	15	23	9	30	35	35	35	25	29	DN12	1/2" (DN15)	20302
18mm x R1/2"	29	18	26	9	30	35	35	35	25	29	DN15	1/2" (DN15)	20304
22mm x R3/4"	30	22	32	9	36	42	40	40	32	37	DN20	3/4" (DN20)	20307
28mm x R1"	31	28	37	8	46	53	44	44	39	45	DN25	1" (DN25)	20309
35mm x R1 1/4"	34	35	44	8	52	60	48	48	49	57	DN32	1 1/4" (DN32)	20310
42mm x R1 1/2"	41	42	54	11	58	67	47	47	51	59	DN40	1 1/2" (DN40)	20311
54mm x R2"	47	54	65	12	75	87	53	53	65	75	DN50	2" (DN50)	20312

### SC69F Straight female union connector

Press x BSP parallel female thread

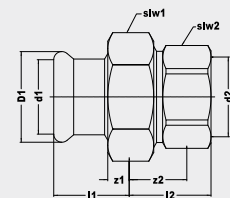

Size	l1	d1	D1	z1	slw1	sks1	l2	z2	slw2	sks2	DN1	DN2	Code
15mm x Rp1/2"	29	15	23	9	30	35	30	15	27	31	DN12	1/2" (DN15)	20313
18mm x Rp1/2"	29	18	26	9	30	35	30	15	27	31	DN15	1/2" (DN15)	20315
22mm x Rp3/4"	30	22	32	9	36	42	33	17	34	39	DN20	3/4" (DN20)	20317
28mm x Rp1"	31	28	37	8	46	53	34	15	42	49	DN25	1" (DN25)	20319
35mm x Rp1 1/4"	34	35	44	8	52	60	42	20	5	58	DN32	1 1/4" (DN32)	20320
42mm x Rp1 1/2"	41	42	54	11	58	67	42	20	55	64	DN40	1 1/2" (DN40)	20321
54mm x Rp2"	47	54	65	12	75	87	46	20	70	81	DN50	2" (DN50)	20322



#### SC640 Carbon steel galvanised heating tube



Size	d1	DN1	Code
1.2mm x 3.0m	15	DN12	45080
1.2mm x 3.0m	18	DN15	45081
1.5mm x 3.0m	22	DN20	45082
1.5mm x 3.0m	28	DN25	45083
1.5mm x 3.0m	35	DN32	45084
1.5mm x 3.0m	42	DN40	45085
1.5mm x 3.0m	54	DN50	45086
1.2mm x 6.0m	15	DN12	25080
1.2mm x 6.0m	18	DN15	25081
1.5mm x 6.0m	22	DN20	25082
1.5mm x 6.0m	28	DN25	25083
1.5mm x 6.0m	35	DN32	25084
1.5mm x 6.0m	42	DN40	25085
1.5mm x 6.0m	54	DN50	25086
1.5mm x 6.0m	67	DN65	25090
2.0mm x 6.0m	76	DN65	25087
2.0mm x 6.0m	89	DN80	25088
2.0mm x 6.0m	108	DN100	25089

#### SC660 Plastic coated galvanised carbon steel heating tube



Size	d1	DN1	Code
2.2mm x 6.0m	15	DN12	25060
2.2mm x 6.0m	18	DN15	25061
2.5mm x 6.0m	22	DN20	25062
2.5mm x 6.0m	28	DN25	25063
2.5mm x 6.0m	35	DN32	25064
2.5mm x 6.0m	42	DN40	25065
2.5mm x 6.0m	54	DN50	25066



## SC645 Galvanized sprinkler tube



Size	d1	DN1	Code
1.5mm x 3.0m	22	DN20	25102
1.5mm x 3.0m	28	DN25	25103
1.5mm x 3.0m	35	DN32	25104
1.5mm x 3.0m	42	DN40	25105
1.5mm x 3.0m	54	DN50	25106
1.5mm x 6.0m	22	DN20	25094
1.5mm x 6.0m	28	DN25	25095
1.5mm x 6.0m	35	DN32	25096
1.5mm x 6.0m	42	DN40	25097
1.5mm x 6.0m	54	DN50	25098
2.0mm x 6.0m	76	DN65	25099
2.0mm x 6.0m	89	DN80	25100
2.0mm x 6.0m	108	DN100	25101



### SG1/G7270 Straight coupling

Press x press

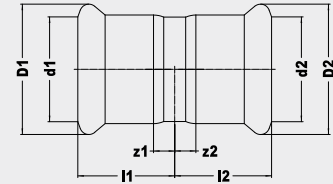

Size	l1	d1	D1	z1	l2	d2	D2	z2	DN1	DN2	Code
15mm	22	15	23	2	22	15	23	2	DN12	DN12	39700
18mm	22	18	26	2	22	18	26	2	DN15	DN15	39699
22mm	23	22	31	2	23	22	31	2	DN20	DN20	39701
28mm	25	28	37	2	25	28	37	2	DN25	DN25	39702
35mm	28	35	44	2	28	35	44	2	DN32	DN32	39703
42mm	36	42	53	4	36	42	53	4	DN40	DN40	39704
54mm	42	54	65	5	42	54	65	5	DN50	DN50	39705
66.7mm	55	67	83	5	55	67	83	5	DN65	DN65	39302
76.1mm	55	76	94	5	55	76	94	5	DN65	DN65	39303
108mm	66	89	108	8	132	89	108	8	DN100	DN100	39305

### SG1FMF/G7510 Composite female metric flange PN16

Press x powder coated steel flange  
to EN 1092-1:1997 (BS 4504)

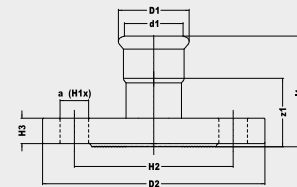

Size	H1	H2	H3	a	l1	d1	D1	z1	D2	DN1	Code
66.7mm DN65 (2 1/2")	4	145	20	18	103	67	83	53	185	DN65	39395
76.1mm DN80 (3")	8	160	20	18	103	76	94	53	200	DN65	39396
108mm DN100 (4")	8	180	20	18	126	108	132	59	220	DN100	39398

### SG1FMM/7520 Composite male metric flange PN16

Male end for insertion into fitting x powder coated  
steel flange to EN 1092-1:1997 (BS 4504)

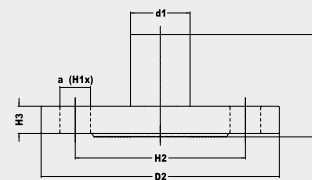

Size	H1	H2	H3	a	l1	d1	D2	DN1	Code
66.7mm DN65 (2 1/2")	4	145	20	18	112	67	185	DN65	39281
76.1mm DN80 (3")	8	160	20	18	113	76	200	DN65	39282
108mm DN100 (4")	8	180	20	18	141	108	220	DN100	39284



### SG1S/G7270SG Slip Straight coupling slip pattern

Press x press (without tube stop)

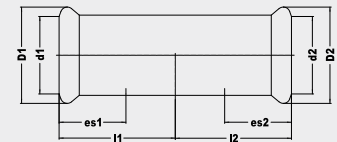

Size	l1	d1	D1	z1	l2	d2	D2	z2	DN1	DN2	Code
15mm	40	15	23	20	40	15	23	20	DN12	DN12	39710
18mm	40	18	26	20	40	18	26	20	DN15	DN15	39709
22mm	42	22	31	21	42	22	31	21	DN20	DN20	39711
28mm	46	28	37	23	46	28	37	23	DN25	DN25	39712
35mm	50	35	44	25	50	35	44	25	DN32	DN32	39713
42mm	60	42	53	30	60	42	53	30	DN40	DN40	39714
54mm	71	54	65	35	71	54	65	35	DN50	DN50	39715
66.7mm	55	67	83	5	55	67	83	5	DN65	DN65	39307
76.1mm	55	67	83	5	55	67	83	5	DN65	DN65	39308
108mm	72	108	132	5	72	108	132	5	DN100	DN100	39310

### SG2/G6270G Straight female connector

Press x BSP parallel female thread

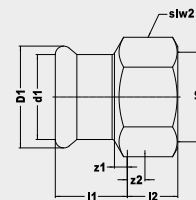

Size	l1	d1	D1	z1	l2	z2	slw2	sks2	DN1	DN2	Code
15mm x Rp1/2"	19	15	23	2	18	8	25	29	DN12	1/2" (DN15)	39720
15mm x Rp3/4"	17	15	23	1	19	8	30	32	DN12	3/4" (DN20)	39721
18mm x Rp1/2"	19	18	26	1	18	8	25	27	DN15	1/2" (DN15)	39716
18mm x Rp3/4"	20	18	26	2	19	9	30	32	DN15	3/4" (DN20)	39717
22mm x Rp1/2"	19	22	31	1	17	7	30	32	DN20	3/4" (DN20)	39722
22mm x Rp3/4"	20	22	31	1	19	9	30	32	DN20	1" (DN25)	39723
28mm x Rp1"	23	28	37	1	22	10	37	39	DN25	3/4" (DN20)	39724
35mm x Rp1 1/4"	25	35	44	1	25	11	46	49	DN32	1" (DN25)	39725
42mm x Rp1 1/2"	27	42	53	1	25	11	48	56	DN40	1 1/4" (DN32)	39726
54mm x Rp2"	32	54	65	1	25	11	48	56	DN50	1 1/4" (DN32)	39727



### SG3/G6243G Straight male connector

Press x BSP taper male thread

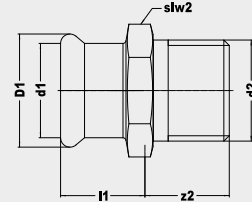

Size	l1	d1	D1	z2	slw2	sks2	DN1	DN2	Code
15mm x R1/2"	20	15	23	8	21	24	DN12	1/2" (DN15)	39730
15mm x R3/4"	20	15	23	10	25	27	DN12	3/4" (DN20)	39731
18mm x R1/2"	20	18	26	9	25	27	DN15	1/2" (DN15)	39728
18mm x R3/4"	20	18	26	10	25	27	DN15	3/4" (DN20)	39729
22mm x R1/2"	21	22	31	9	30	32	DN20	1/2" (DN15)	39732
22mm x R3/4"	21	22	31	10	30	32	DN20	3/4" (DN20)	39733
22mm x R1"	21	22	31	11	32	32	DN20	1" (DN25)	39734
28mm x R3/4"	23	28	37	10	36	38	DN25	3/4" (DN20)	39737
28mm x R1"	23	28	37	11	36	38	DN25	1" (DN25)	39735
28mm x R1 1/4"	23	28	37	12	40	42	DN25	1 1/4" (DN32)	39736
35mm x R1"	26	35	44	12	41	44	DN32	1" (DN25)	39738
35mm x R1 1/4"	26	35	44	15	41	44	DN32	1 1/4" (DN32)	39739
42mm x R1 1/4"	30	42	53	16	51	54	DN40	1 1/4" (DN32)	39741
42mm x R1 1/2"	30	42	53	16	51	53	DN40	1 1/2" (DN40)	39740
54mm x R2"	35	54	65	12	-	66	DN50	2" (DN50)	39742
66.7mm x R2 1/2"	50	67	83	25	74	82	DN65	2 1/2" (DN65)	39311
76.1mm x R3"	50	76	94	39	77	89	DN65	3" (DN80)	39313
108mm x R4"	68	108	132	38	107	124	DN100	4" (DN100)	39315

### SG6/G7243 Reducer

Larger male end for insertion into a fitting x press

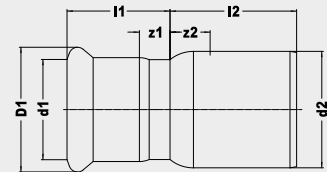

Size	l1	d1	D1	z1	l2	d2	z2	DN1	DN2	Code
18 x 15mm	24	15	23	4	23	18	3	DN12	DN15	39761
22 x 15mm	24	15	23	4	28	22	7	DN12	DN20	39750
22 x 18mm	24	18	26	4	26	22	5	DN15	DN20	39762
28 x 15mm	25	15	23	4	37	28	14	DN12	DN25	39751
28 x 18mm	24	18	26	4	26	28	5	DN15	DN25	39763
28 x 22mm	25	22	31	4	30	28	7	DN20	DN25	39752
35 x 22mm	29	22	31	9	39	35	13	DN20	DN32	39753
35 x 28mm	28	28	37	5	35	35	9	DN25	DN32	39754
42 x 22mm	25	22	31	4	49	42	19	DN20	DN40	39755
42 x 28mm	27	28	37	4	44	42	14	DN25	DN40	39756



Size	l1	d1	D1	z1	l2	d2	z2	DN1	DN2	Code
42 x 35mm	35	35	44	8	38	42	8	DN32	DN40	39757
54 x 28mm	27	28	37	4	59	54	24	DN25	DN50	39760
54 x 35mm	35	35	44	9	53	54	18	DN32	DN50	39758
54 x 42mm	40	42	53	9	47	54	12	DN40	DN50	39759
66.7 x 28mm	37	28	37	14	72	67	22	DN25	DN65	39319
66.7 x 35mm	40	35	44	14	69	67	19	DN32	DN65	39320
66.7 x 42mm	43	42	53	13	67	67	17	DN40	DN65	39321
66.7 x 54mm	49	54	65	14	63	67	13	DN50	DN65	39322
76.1 x 35mm	39	35	44	13	74	76	24	DN32	DN65	39323
76.1 x 42mm	43	42	53	13	70	76	20	DN40	DN65	39324
76.1 x 54mm	52	54	65	17	64	76	14	DN50	DN65	39325
76.1 x 66.7mm	66	67	83	16	60	76	10	DN65	DN65	39327
108 x 42mm	47	42	53	17	106	108	39	DN40	DN100	39334
108 x 54mm	54	54	65	20	102	108	35	DN50	DN100	39335
108 x 66.7mm	70	67	83	20	96	108	29	DN65	DN100	39337
108 x 76.1mm	70	76	94	20	92	108	25	DN65	DN100	39338

## SG11/G6330 Union coupling

Press x press

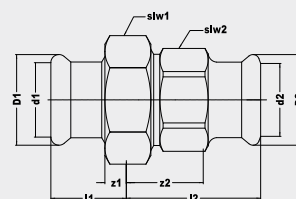

Size	l1	d1	D1	z1	slw1	sks1	l2	d2	D2	z2	slw2	sks2	DN1	DN2	Code
15mm	25	15	23	5	34	37	36	15	23	16	28	30	DN12	DN12	39770
18mm	29	18	26	9	41	44	38	18	26	18	36	38	DN15	DN15	39906
22mm	29	22	31	8	41	44	38	22	31	17	36	38	DN20	DN20	39771
28mm	34	28	37	11	48	52	41	28	37	18	41	44	DN25	DN25	39772
35mm	36	35	44	10	58	63	46	35	44	20	50	53	DN32	DN32	39773
42mm	46	42	53	16	65	70	51	42	53	21	55	58	DN40	DN40	39774
54mm	46	54	65	11	80	86	58	54	65	23	70	74	DN50	DN50	39775



### SG12/G7002A Elbow

Press x press

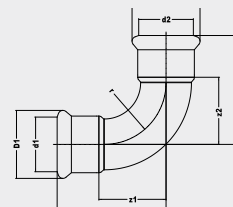

Size	l1	d1	D1	z1	l2	d2	D2	z2	DN1	DN2	Code
15mm	38	15	23	17	38	15	23	17	DN12	DN12	39780
18mm	42	18	26	22	42	18	26	22	DN15	DN15	39779
22mm	47	22	31	26	47	22	31	26	DN20	DN20	39781
28mm	56	28	37	34	56	28	37	34	DN25	DN25	39782
35mm	68	35	44	42	68	35	44	42	DN32	DN32	39783
42mm	80	42	53	50	80	42	53	50	DN40	DN40	39784
54mm	100	54	65	65	100	54	65	65	DN50	DN50	39785
66.7mm	132	67	83	87	132	67	83	87	DN65	DN65	39341
76.1mm	142	76	94	92	142	76	94	92	DN65	DN65	39342
108mm	201	108	131	135	201	108	131	140	DN100	DN100	39344

### SG12S/G7001A Street elbow

Press x male end for insertion into a fitting

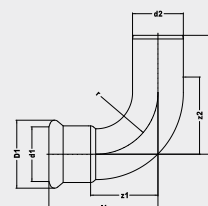

Size	l1	d1	D1	z1	l2	d2	z2	DN1	DN2	Code
15mm	36	15	23	16	50	15	30	DN12	DN12	39790
18mm	42	18	26	22	53	18	33	DN15	DN15	39789
22mm	47	22	31	27	58	22	38	DN20	DN20	39791
28mm	58	28	37	34	64	28	40	DN25	DN25	39792
35mm	69	35	44	44	82	35	57	DN32	DN32	39793
42mm	81	42	53	52	101	42	72	DN40	DN40	39794
54mm	100	54	65	66	120	54	86	DN50	DN50	39795
66.7mm	130	67	83	93	175	67	125	DN65	DN65	39346
76.1mm	143	76	94	93	150	76	-	DN65	DN65	39347
108mm	197	108	132	132	208	108	141	DN100	DN100	39349



## SG13/G6092G Male elbow

Press x BSP taper male thread

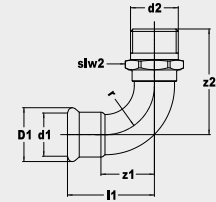

Size	l1	d1	D1	z1	l2	z2	DN1	DN2	Code
15mm x R1/2"	37	15	23	18	67	59	DN12	1/2" (DN15)	39800
18mm x R1/2"	64	18	26	35	34	26	DN15	1/2" (DN15)	39806
18mm x R3/4"	55	18	26	35	37	38	DN15	3/4" (DN20)	39807
22mm x R3/4"	48	22	31	27	79	70	DN20	3/4" (DN20)	39801
28mm x R1"	57	28	37	34	88	78	DN25	1" (DN25)	39802
35mm x R1 1/4"	78	35	44	53	60	60	DN32	1 1/4" (DN32)	39803
42mm x R1 1/2"	104	42	53	74	57	60	DN40	1 1/2" (DN40)	39804
54mm x R2"	112	54	65	77	80	80	DN50	2" (DN50)	39805

## SG14/G6090G Female elbow

Press x parallel female thread

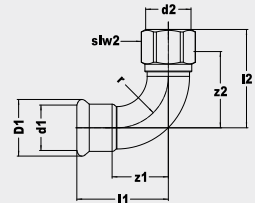

Size	l1	d1	D1	z1	l2	z2	DN1	DN2	Code
15mm x Rp1/2"	37	15	23	17	65	50	DN12	1/2" (DN15)	39810
15mm x Rp3/4"	58	15	23	38	30	15	DN12	3/4" (DN20)	39811
18mm x Rp1/2"	42	18	26	22	68	53	DN15	1/2" (DN15)	39808
18mm x Rp3/4"	52	18	26	32	30	15	DN15	3/4" (DN20)	39809
22mm x Rp1/2"	48	22	31	27	73	58	DN20	1/2" (DN15)	39813
22mm x Rp3/4"	48	22	31	27	77	62	DN20	3/4" (DN20)	39814
22mm x Rp1"	48	22	31	27	80	61	DN20	1" (DN25)	39812
28mm x Rp1"	58	28	37	37	89	70	DN25	1" (DN25)	39815
35mm x Rp1 1/4"	75	35	44	50	45	25	DN32	1 1/4" (DN32)	39816
42mm x Rp1 1/2"	80	42	53	60	128	107	DN40	1 1/2" (DN40)	39817
54mm x Rp2"	100	54	65	65	155	129	DN50	2" (DN50)	39818



### SG15/G6471G Backplate elbow

Press x BSP parallel female thread

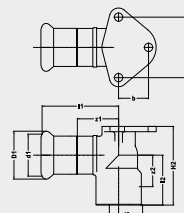

Size	l1	d1	D1	z1	l2	z2	DN1	DN2	Code
15mm x 1/2"	48	15	23	28	23	11	DN12	1/2" (DN15)	39820
18mm x 1/2"	50	18	26	30	24	12	DN15	1/2" (DN15)	39819
22mm x 3/4"	60	22	32	39	31	14	DN20	3/4" (DN20)	39821

### SG21/G7041 Obtuse elbow

Press x press

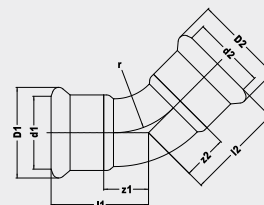

Size	l1	d1	D1	z1	l2	d2	D2	z2	DN1	DN2	Code
15mm	28	15	23	8	28	15	23	8	DN12	DN12	39825
18mm	29	18	26	9	29	18	26	9	DN15	DN15	39823
22mm	31	22	31	12	31	22	31	12	DN20	DN20	39826
28mm	37	28	37	16	37	28	37	16	DN25	DN25	39827
35mm	44	35	44	18	44	35	44	18	DN32	DN32	39828
42mm	51	42	53	21	51	42	53	21	DN40	DN40	39829
54mm	62	54	65	27	62	54	65	27	DN50	DN50	39830
66.7mm	85	67	83	35	85	67	83	35	DN65	DN65	39351
76.1mm	91	76	94	45	91	76	94	45	DN65	DN65	39352
108mm	125	108	132	59	125	108	132	59	DN100	DN100	39354



### SG21S/G7040 Obtuse street elbow

Press x male end for insertion into a fitting

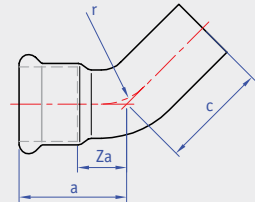

Size	l1	d1	D1	z1	l2	d2	z2	DN1	DN2	Code
15mm	28	15	23	8	37	15	17	DN12	DN12	39835
18mm	29	18	26	9	39	18	19	DN15	DN15	39833
22mm	32	22	31	11	44	22	23	DN20	DN20	39836
28mm	37	28	37	14	47	28	24	DN25	DN25	39837
35mm	43	35	44	17	58	35	32	DN32	DN32	39838
42mm	51	42	53	21	71	42	41	DN40	DN40	39839
54mm	62	54	65	27	82	54	47	DN50	DN50	39840
66.7mm	85	67	83	35	88	67	38	DN65	DN65	39356
76.1mm	90	76	94	40	97	76	54	DN65	DN65	39357
108mm	121	108	132	58	136	108	69	DN100	DN100	39359

### SG22/G7086 Partial crossover

Press x male end for insertion into a fitting

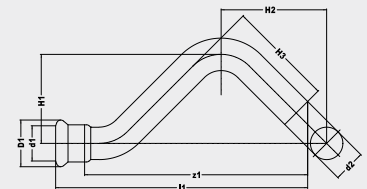

Size	l1	d1	D1	z1	d2	DN1	DN2	Code
15mm	110	15	23	90	15	DN12	DN12	39841
18mm	120	18	26	100	18	DN15	DN15	39842
22mm	135	22	31	114	22	DN20	DN20	39843

### S22S/7087 Full crossover

Both ends male for insertion into a fitting

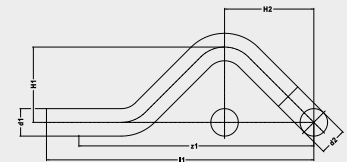

Size	l1	d1	d2	DN1	DN2	Code
15mm	118	15	15	DN12	DN12	38438
18mm	128	18	18	DN15	DN15	38434
22mm	142	22	22	DN20	DN20	38439



### SG23/G7085 Full crossover

Press x press

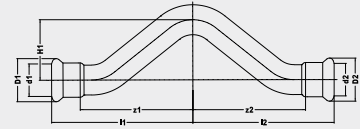

Size	l1	d1	D1	z1	l2	d2	D2	z2	DN1	DN2	Code
15mm	70	15	23	50	70	15	23	50	DN12	DN12	39844
18mm	76	18	26	56	76	18	26	56	DN15	DN15	39845
22mm	85	22	31	64	85	22	31	64	DN20	DN20	39846

### SG24/G7130 Equal tee

Press on all ends

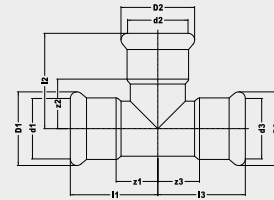
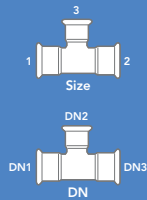

Size	l1	d1	D1	z1	l2	d2	D2	z2	l3	d3	D3	z3	DN1	DN2	DN3	Code
15mm	32	15	23	12	32	15	23	12	32	15	23	12	DN12	DN12	DN12	39850
18mm	34	18	26	14	34	18	26	14	34	18	26	14	DN15	DN15	DN15	39847
22mm	37	22	31	16	37	22	31	16	37	22	31	16	DN20	DN20	DN20	39851
28mm	42	28	37	19	42	28	37	19	42	28	37	19	DN25	DN25	DN25	39852
35mm	50	35	44	24	50	35	44	24	50	35	44	24	DN32	DN32	DN32	39853
42mm	58	42	53	28	58	42	53	28	58	42	53	28	DN40	DN40	DN40	39854
54mm	69	54	65	34	69	54	65	34	69	54	65	34	DN50	DN50	DN50	39855
66.7mm	95	67	83	45	111	67	83	62	95	67	83	45	DN65	DN65	DN65	39361
76.1mm	101	76	94	51	119	76	94	69	101	76	94	51	DN65	DN65	DN65	39362
108mm	159	108	132	92	159	108	132	92	159	108	132	92	DN100	DN100	DN100	39364



## SG25/G7130 Tee, reduced branch

Press on all ends

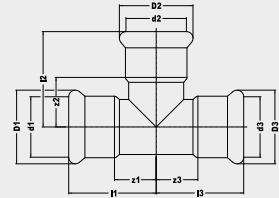
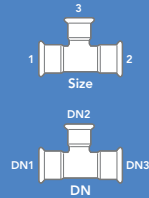

Size	l1	d1	D1	z1	l2	d2	D2	z2	l3	d3	D3	z3	DN1	DN2	DN3	Code
18 x 18 x 15mm	34	18	26	14	35	15	23	15	34	18	26	14	DN15	DN12	DN15	39856
22 x 22 x 15mm	37	22	31	16	38	15	23	18	37	22	31	16	DN20	DN12	DN20	39860
22 x 22 x 18mm	37	22	31	16	38	18	26	18	37	22	31	16	DN20	DN15	DN20	39868
28 x 28 x 15mm	42	28	37	19	41	15	23	21	42	28	37	19	DN25	DN12	DN25	39861
28 x 28 x 18mm	42	28	37	19	41	18	26	21	42	28	37	19	DN25	DN15	DN25	39857
28 x 28 x 22mm	42	28	37	19	41	22	31	20	42	28	37	19	DN25	DN20	DN25	39862
35 x 35 x 22mm	45	35	44	19	45	22	31	24	45	35	44	19	DN32	DN20	DN32	39863
35 x 35 x 28mm	50	35	44	24	44	28	37	21	50	35	44	24	DN32	DN25	DN32	39864
42 x 42 x 22mm	50	42	53	20	48	22	31	27	50	42	53	20	DN40	DN20	DN40	39869
42 x 42 x 28mm	56	42	53	26	49	28	37	26	56	42	53	26	DN40	DN25	DN40	39865
42 x 42 x 35mm	56	42	53	26	50	35	44	24	56	42	53	26	DN40	DN32	DN40	39866
54 x 54 x 22mm	60	54	65	25	54	22	31	33	60	54	65	25	DN50	DN20	DN50	39871
54 x 54 x 42mm	69	54	65	34	64	42	53	34	69	54	65	34	DN50	DN40	DN50	39867
66.7 x 66.7 x 28mm	76	67	83	26	67	28	37	43	76	67	83	26	DN65	DN25	DN65	39368
66.7 x 66.7 x 35mm	80	67	83	29	70	35	44	43	80	67	83	29	DN65	DN32	DN65	39369
66.7 x 66.7 x 42mm	82	67	83	32	76	42	53	41	82	67	83	32	DN65	DN40	DN65	39370
66.7 x 66.7 x 54mm	88	67	83	47	78	54	65	43	88	67	83	47	DN65	DN50	DN65	39371
76.1 x 76.1 x 22mm	73	76	94	22	73	22	31	50	73	76	94	22	DN65	DN20	DN65	39372
76.1 x 76.1 x 28mm	77	76	94	26	73	28	37	50	77	76	94	26	DN65	DN25	DN65	39373
76.1 x 76.1 x 35mm	80	76	94	30	78	35	44	53	80	76	94	30	DN65	DN32	DN65	39374
76.1 x 76.1 x 42mm	103	76	94	55	106	42	53	70	103	76	94	55	DN65	DN40	DN65	39375
76.1 x 76.1 x 54mm	93	76	94	41	85	54	65	50	93	76	94	60	DN65	DN50	DN65	39376
108 x 108 x 54mm	109	89	108	40	125	54	65	91	109	89	108	40	DN100	DN50	DN100	39382
108 x 108 x 66.7mm	117	108	133	50	136	67	83	86	117	108	133	50	DN100	DN65	DN100	39383
108 x 108 x 76.1mm	120	108	133	56	136	54	65	86	120	108	133	56	DN100	DN65	DN100	39384



### SG26/G7130 Tee, one end reduced

Press on all ends

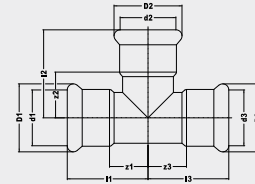
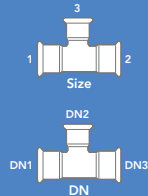

Size	l1	d1	D1	z1	l2	d2	D2	z2	l3	d3	D3	z3	DN1	DN2	DN3	Code
22 x 15 x 22mm	37	22	31	16	37	22	31	16	46	15	23	26	DN20	DN20	DN12	39870

### SG27/G7130 Tee, one end and branch reduced

Press on all ends

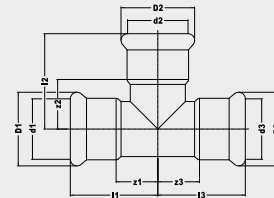
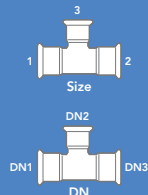

Size	l1	d1	D1	z1	l2	d2	D2	z2	l3	d3	D3	z3	DN1	DN2	DN3	Code
22 x 15 x 15mm	37	22	31	16	44	15	23	18	43	15	23	23	DN20	DN12	DN12	39875

### SG30/G6130G Female branch tee

Press x BSP parallel female branch

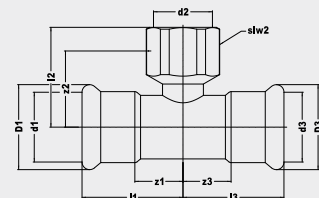
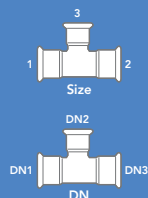

Size	l1	d1	D1	z1	l2	z2	l3	d3	D3	z3	slw2	DN1	DN2	DN3	Code
15 x 15mm x Rp1/2"	32	15	23	12	59	44	32	15	23	12	22	DN12	1/2" (DN15)	DN12	39890
18 x 18mm x Rp1/2"	34	18	26	14	24	47	34	18	26	14	22	DN15	1/2" (DN15)	DN15	39891
22 x 22mm x Rp1/2"	37	22	31	16	65	50	37	22	31	16	22	DN20	1/2" (DN15)	DN20	39892
22 x 22mm x Rp3/4"	37	22	31	16	67	51	37	22	31	16	30	DN20	3/4" (DN20)	DN20	39893
28 x 28mm x Rp1/2"	42	28	37	19	29	53	42	28	37	19	22	DN25	1/2" (DN15)	DN25	39894
28 x 28mm x Rp3/4"	42	28	37	19	34	52	42	28	37	19	30	DN25	3/4" (DN20)	DN25	39895
35 x 35mm x Rp1/2"	45	35	44	16	34	63	45	35	44	16	22	DN32	1/2" (DN15)	DN32	39896
35 x 35mm x Rp1"	50	35	44	24	34	14	50	35	44	24	46	DN32	3/4" (DN20)	DN32	38897
42 x 42mm x Rp1/2"	50	42	53	19	38	61	50	42	53	19	48	DN40	1/2" (DN15)	DN40	39898
54 x 54mm x Rp1/2"	60	54	65	26	44	70	60	54	65	26	65	DN50	1/2" (DN15)	DN50	39899
76.1 x 76.1mm x Rp1/2"	65	76	94	15	48	30	65	76	94	15	-	DN65	1/2" (DN15)	DN65	39386
108 x 108mm x Rp1/2"	82	108	133	16	63	-	82	108	133	16	-	DN100	1/2" (DN15)	DN100	39388



## SG61/G7301 Stop end

Press for use on copper tube

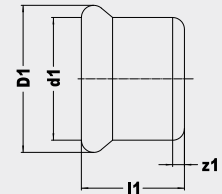

Size	l1	d1	D1	z1	DN1	Code
15mm	20	15	23	2	DN12	39880
18mm	20	18	26	2	DN15	39878
22mm	21	22	31	2	DN20	39881
28mm	23	28	37	2	DN25	39882
35mm	26	35	44	2	DN32	39883
42mm	30	42	53	2	DN40	39884
54mm	35	54	65	2	DN50	39885
66.7mm	89	67	83	1	DN65	39390
76.1mm	74	76	94	2	DN65	39391
108mm	95	1.8	132	2	DN80	39393

## SG68FF/G6360 Union

Press x female union nut

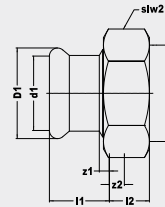

Size	d1	D1	slw2	sks2	DN1	DN2	Code
15mm x G7/8"	15	23	34	39	DN12	7/8" (DN12)	39910
22mm x G1 1/8"	22	31	41	47	DN20	1 1/8" (DN20)	39911
28mm x G1 3/8"	28	37	48	55	DN25	1 3/8" (DN25)	39912



### SSG1/7270 Straight coupling

Press x press

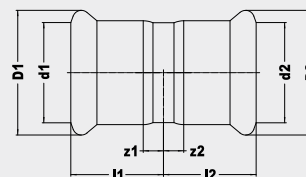

Size	l1	d1	D1	z1	l2	d2	D2	z2	DN1	DN2	Code
15mm	26	15	23	5	26	15	23	5	DN12	DN12	11800
22mm	30	22	32	7	30	22	32	7	DN20	DN20	11802
28mm	31	28	38	7	31	28	38	7	DN25	DN25	11803
35mm	36	35	45	9	36	35	45	9	DN32	DN32	11804
42mm	40	42	54	8	40	42	54	8	DN40	DN40	11805
54mm	45	54	65	8	45	54	65	8	DN50	DN50	11806
76.1mm	71	76	94	16	71	76	94	16	DN65	DN65	20481
88.9mm	82	89	109	19	82	89	109	19	DN80	DN80	20482
108mm	96	108	133	19	96	108	133	19	DN100	DN100	20483

### SSG1 FMF Composite flange

Size	l1	d1	D1	z1	D2	H2	H3	a	DN1	DN2	Code
76.1mm x DN65 (2 1/2")	126	76	94	71	185	145	18	18	DN65	DN65	20475
88.9mm x DN80 (3")	147	89	109	84	200	160	20	18	DN80	DN80	20476
108mm x DN100 (4")	167	108	133	90	220	180	20	18	DN100	DN100	20477

### SSG1S/7270S Straight coupling slip pattern

Press x press (without tube stop)

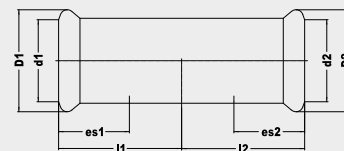

Size	l1	d1	D1	l2	d2	D2	DN1	DN2	Code
15mm	36	15	23	36	15	23	DN12	DN12	11808
22mm	41	22	32	41	22	32	DN20	DN20	11810
28mm	45	28	38	45	28	38	DN25	DN25	11811
35mm	50	35	45	50	35	45	DN32	DN32	11812
42mm	58	42	54	58	42	54	DN40	DN40	11813
54mm	70	54	65	70	54	65	DN50	DN50	11814



## FEATURES

✚ Designed for use on above ground 2nd and 3rd family gas services

✚ Designed to suit applications where high levels of hydrogen sulphide lead to dust problems in copper pipelines

✚ Designed for use with XPress stainless steel system tube

### SSG2/6270G Straight female connector

Press x BSP parallel female thread

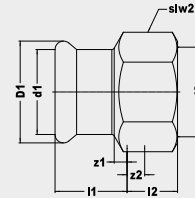

Size	l1	d1	D1	z1	l2	z2	slw2	sks2	DN1	DN2	Code
15mm x Rp1/2"	27	15	23	10	27	10	22	25	DN12	1/2" (DN15)	11928
22mm x Rp1/2"	28	22	32	10	28	10	22	25	DN20	1/2" (DN15)	11930
22mm x Rp3/4"	35	22	32	16	35	16	27	31	DN20	3/4" (DN20)	11931
28mm x Rp1"	31	28	38	11	31	11	36	40	DN25	1" (DN25)	11933
35mm x Rp1 1/4"	36	35	45	14	36	14	46	52	DN32	1 1/4" (DN32)	11934
42mm x Rp1 1/2"	37	42	54	13	37	13	50	56	DN40	1 1/2" (DN40)	11936
54mm x Rp2"	53	54	65	26	53	26	65	72	DN50	2" (DN50)	11937

### SSG3/6243G Straight male connector

Press x BSP parallel female thread

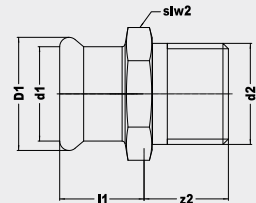

Size	l1	d1	D1	z1	l2	z2	slw2	sks2	DN1	DN2	Code
15mm x R1/2"	25	15	23	5	28	15	22	25	DN12	1/2" (DN15)	11914
22mm x R3/4"	29	22	32	8	30	16	27	31	DN20	3/4" (DN20)	11917
28mm x R1"	29	28	38	6	33	16	36	40	DN25	1" (DN25)	11919
35mm x R1 1/4"	34	35	45	8	36	17	46	52	DN32	1 1/4" (DN32)	11920
42mm x R1 1/2"	38	42	54	8	37	18	50	56	DN40	1 1/2" (DN40)	11923
54mm x R2"	44	54	65	9	43	20	65	72	DN50	2" (DN50)	11924
76.1mm x R2 1/2"	55	76	94	-	-	-	-	-	DN65	2 1/2" (DN65)	20485
88.9mm x R3"	63	89	109	-	-	-	-	-	DN80	3" (DN80)	20486

### SSG6/7243 Reducer

Larger male end for insertion into a fitting x press

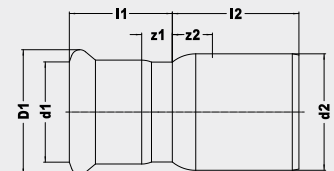

Size	l1	d1	D1	z1	l2	d2	z2	DN1	DN2	Code
22 x 15mm	26	15	23	6	34	-	22	DN12	DN20	11849
28 x 15mm	25	15	23	5	32	-	28	DN12	DN25	11851
28 x 22mm	29	22	32	8	38	-	35	DN20	DN32	11853
35 x 22mm	40	22	32	19	43	-	35	DN20	DN32	11854
35 x 28mm	30	28	38	7	43	-	35	DN25	DN32	11855



Size	l1	d1	D1	z1	l2	d2	z2	DN1	DN2	Code
42 x 28mm	40	28	38	17	58	42	28	DN25	DN40	11856
42 x 35mm	40	35	45	17	59	42	24	DN32	DN40	11857
54 x 28mm	37	28	38	11	42	54	12	DN25	DN50	11858
54 x 35mm	50	35	45	24	78	54	43	DN32	DN50	11859
54 x 42mm	37	42	54	7	60	54	25	DN40	DN50	11860
76.1 x 42mm	50	42	54	20	101	76	46	DN40	DN65	20491
76.1 x 54mm	50	54	65	15	154	76	77	DN50	DN65	20492
88.9 x 54mm	50	54	65	15	90	89	35	DN50	DN80	20493
88.9 x 76.1mm	50	76	94	15	106	89	43	DN65	DN80	20494
108 x 54mm	65	54	65	10	131	108	54	DN50	DN100	20495
108 x 76.1mm	65	76	94	10	91	108	28	DN65	DN100	20496
108 x 88.9mm	78	89	109	15	112	108	35	DN80	DN100	20497

### SSG12/7002A Elbow

Press x press

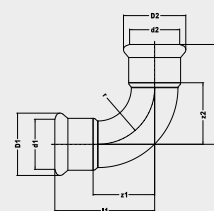

Size	l1	d1	D1	z1	l2	d2	D2	z2	DN1	DN2	Code
15mm	48	15	23	27	48	15	23	27	DN12	DN12	11816
22mm	60	22	32	37	60	22	32	37	DN20	DN20	11818
28mm	71	28	38	47	71	28	38	47	DN25	DN25	11819
35mm	87	35	45	60	87	35	45	60	DN32	DN32	11820
42mm	115	42	54	83	115	42	54	83	DN40	DN40	11821
54mm	142	54	65	105	142	54	65	105	DN50	DN50	11822
76.1mm	150	76	94	95	150	76	94	95	DN65	DN65	20501
88.9mm	174	89	109	111	174	89	109	111	DN80	DN80	20502
108mm	215	108	133	138	215	108	133	138	DN100	DN100	20503

### SSG12S/7001A Street elbow

Press x male end for insertion into a fitting

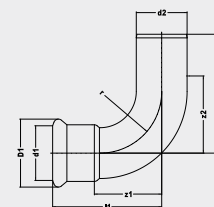

Size	l1	d1	D1	z1	l2	d2	z2	DN1	DN2	Code
15mm	48	15	23	27	56	15	56	DN12	DN12	11824
22mm	60	22	32	37	68	22	68	DN20	DN20	11826
28mm	71	28	38	47	80	28	80	DN25	DN25	11827
35mm	87	35	45	60	93	35	67	DN32	DN32	11828
42mm	115	42	54	83	125	42	95	DN40	DN40	11829



Size	l1	d1	D1	z1	l2	d2	z2	DN1	DN2	Code
54mm	142	54	65	105	149	54	114	DN50	DN50	11830
76.1mm	150	76	94	95	465	76	-	DN65	DN65	20505
88.9mm	175	89	109	112	190	89	-	DN80	DN80	20506
108mm	216	108	133	138	238	108	-	DN100	DN100	20507

### SSG13/6092G Male elbow

Press x BSP taper male thread

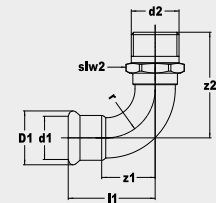

Size	d1	D1	z2	DN1	DN2	Code
15mm x R1/2"	15	23	14	DN12	1/2" (DN15)	11940
22mm x R3/4"	22	32	14	DN20	3/4" (DN20)	11942
28mm x R1"	28	38	15	DN25	1" (DN25)	11943
35mm x R1 1/4"	35	45	13	DN32	1 1/4" (DN32)	11944

### SSG14/6090G Female elbow

Press x BSP parallel female thread

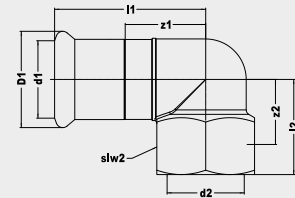

Size	l1	d1	D1	z1	l2	z2	DN1	DN2	Code
15mm x Rp1/2"	53	15	23	32	36	24	DN12	1/2" (DN15)	11950
22mm x Rp3/4"	57	22	32	34	46	33	DN20	3/4" (DN20)	11952
28mm x Rp1"	71	28	38	47	54	38	DN25	1" (DN25)	11953
35mm x Rp1 1/4"	72	35	45	45	62	45	DN32	1 1/4" (DN32)	11954

### SSG15/6472G Backplate elbow

Press x BSP parallel female thread

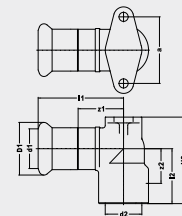

Size	d1	D1	DN1	DN2	Code
15mm x 1/2"	15	23	DN12	1/2" (DN15)	11957
22mm x 3/4"	22	32	DN20	3/4" (DN20)	11959



### SSG21/7041 Obtuse elbow

Press x press

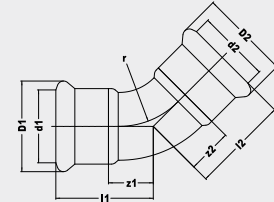

Size	l1	d1	D1	z1	l2	d2	D2	z2	DN1	DN2	Code
15mm	37	15	23	16	37	15	23	16	DN12	DN12	11832
22mm	44	22	32	21	44	22	32	21	DN20	DN20	11834
28mm	51	28	38	27	51	28	38	27	DN25	DN25	11835
35mm	59	35	45	32	59	35	45	32	DN32	DN32	11836
42mm	77	42	54	45	77	42	54	45	DN40	DN40	11837
54mm	88	54	65	51	88	54	65	51	DN50	DN50	11838
76.1mm	98	76	94	43	98	76	94	43	DN65	DN65	20511
88.9mm	112	89	109	49	112	89	109	49	DN80	DN80	20512
108mm	138	108	133	61	138	108	133	61	DN100	DN100	20513

### SSG21S/7040 Obtuse street elbow

Press x male end for insertion into a fitting

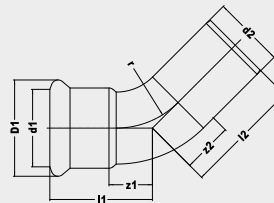

Size	l1	d1	D1	z1	l2	d2	z2	DN1	DN2	Code
15mm	37	15	23	16	48	15	28	DN12	DN12	11840
22mm	44	22	32	21	53	22	32	DN20	DN20	11842
28mm	51	28	38	27	60	28	37	DN25	DN25	11843
35mm	59	35	45	32	66	35	40	DN32	DN32	11844
42mm	77	42	54	45	80	42	50	DN40	DN40	11845
54mm	88	54	65	51	97	54	62	DN50	DN50	11846
76.1mm	98	76.1	94	43	117	76	62	DN65	DN65	20516
88.9mm	112	89	109	49	131	89	68	DN80	DN80	20517
108mm	138	108	133	61	154	108	77	DN100	DN100	20518



## SSG24/7130 Equal tee

Press on all ends

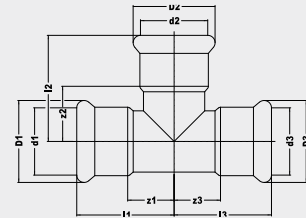
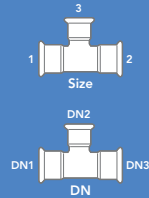

Size	l1	d1	D1	z1	l2	d2	D2	z2	l3	d3	D3	z3	DN1	DN2	DN3	Code
15mm	37	15	23	16	35	15	23	14	37	15	23	16	DN12	DN12	DN12	11865
22mm	41	22	32	18	40	22	32	17	41	22	32	18	DN20	DN20	DN20	11867
28mm	46	28	38	22	45	28	38	21	46	28	38	22	DN25	DN25	DN25	11868
35mm	51	35	45	24	55	35	45	28	51	35	45	24	DN32	DN32	DN32	11869
42mm	59	42	54	27	61	42	54	29	59	42	54	27	DN40	DN40	DN40	11870
54mm	71	54	65	34	72	54	65	35	71	54	65	34	DN50	DN50	DN50	11871
76.1mm	116	76	94	61	115	76	96	61	116	76	94	60	DN65	DN65	DN65	20521
88.9mm	156	89	109	68	156	89	109	68	156	89	109	68	DN80	DN80	DN80	20522
108mm	231	108	133	79	231	108	133	79	231	108	133	78	DN100	DN100	DN100	20523

## SSG25/7130 Reduced branch tee

Press on all ends

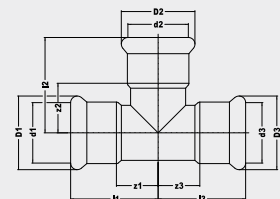
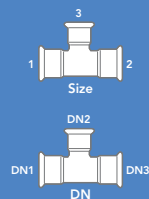

Size	l1	d1	D1	z1	l2	d2	D2	z2	l3	d3	D3	z3	DN1	DN2	DN3	Code
22 x 22 x 15mm	41	22	32	18	39	15	23	18	41	22	32	18	DN20	DN12	DN20	11873
28 x 28 x 15mm	46	28	38	22	42	15	23	21	46	28	38	22	DN25	DN12	DN25	11875
28 x 28 x 22mm	46	28	38	22	45	22	32	22	46	28	38	22	DN25	DN20	DN25	11877
35 x 35 x 15mm	51	35	45	24	45	15	23	24	51	35	45	24	DN32	DN12	DN32	11878
35 x 35 x 22mm	51	35	45	24	46	22	32	23	51	35	45	24	DN32	DN20	DN32	11880
35 x 35 x 28mm	51	35	45	24	48	28	38	24	51	35	45	24	DN32	DN25	DN32	11881
42 x 42 x 22mm	59	42	54	27	51	22	32	28	59	42	54	27	DN40	DN20	DN40	11882
42 x 42 x 28mm	59	42	54	27	53	28	38	29	59	42	54	27	DN40	DN25	DN40	11883
42 x 42 x 35mm	59	42	54	27	60	35	45	33	59	42	54	27	DN40	DN32	DN40	11884
54 x 54 x 22mm	71	54	65	34	59	22	32	34	71	54	65	34	DN50	DN20	DN50	11885
54 x 54 x 28mm	71	54	65	34	60	28	38	36	71	54	65	34	DN50	DN25	DN50	11886
54 x 54 x 35mm	71	54	65	34	66	35	45	39	71	54	65	34	DN50	DN32	DN50	11887
54 x 54 x 42mm	71	54	65	34	64	42	54	32	71	54	65	34	DN50	DN40	DN50	11888
76.1 x 76.1 x 22mm	116	76	94	61	68	22	32	-	116	76	94	45	DN65	DN20	DN65	20528
76.1 x 76.1 x 28mm	116	76	94	61	71	28	38	-	116	76	94	47	DN65	DN25	DN65	20529
76.1 x 76.1 x 35mm	116	76	94	61	75	35	45	-	116	76	94	48	DN65	DN32	DN65	20530
76.1 x 76.1 x 42mm	116	76	94	61	79	42	54	-	116	76	94	47	DN65	DN40	DN65	20531
76.1 x 76.1 x 54mm	116	76	94	61	80	54	65	-	116	76	94	43	DN65	DN50	DN65	20532



Size	l1	d1	D1	z1	l2	d2	D2	z2	l3	d3	D3	z3	DN1	DN2	DN3	Code
88.9 x 88.9 x 22mm	131	89	109	68	76	22	32	-	131	89	109	53	DN80	DN20	DN80	20533
88.9 x 88.9 x 28mm	131	89	109	68	76	28	38	-	131	89	109	52	DN80	DN25	DN80	20534
88.9 x 88.9 x 35mm	131	89	109	68	83	35	45	-	131	89	109	56	DN80	DN32	DN80	20535
88.9 x 88.9 x 42mm	131	89	109	68	85	42	54	-	131	89	109	53	DN80	DN40	DN80	20536
88.9 x 88.9 x 54mm	131	89	109	68	93	54	65	-	131	89	109	56	DN80	DN50	DN80	20537
108 x 108 x 22mm	156	108	133	79	85	22	32	-	156	108	133	62	DN100	DN20	DN100	20538
108 x 108 x 28mm	156	108	133	79	88	28	38	-	156	108	133	64	DN100	DN25	DN100	20539
108 x 108 x 35mm	156	108	133	79	94	35	45	-	156	108	133	67	DN100	DN32	DN100	20540
108 x 108 x 42mm	156	108	133	79	96	42	54	-	156	108	133	64	DN100	DN40	DN100	20541
108 x 108 x 54mm	156	108	133	79	102	54	65	-	156	108	133	65	DN100	DN50	DN100	20542

### SSG30/6130G Female branch tee

Press x BSP parallel female branch

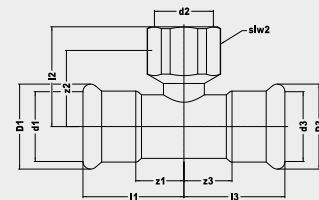
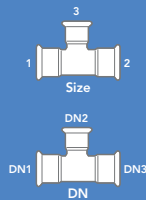

Size	l1	d1	D1	z1	l2	d2	z2	l3	d3	D3	z3	slw2	DN1	DN2	DN3	Code
15 x 15mm x Rp1/2"	37	15	23	16	37	1/2"	25	37	15	23	16	24	DN12	1/2" (DN15)	DN12	11900
22 x 22mm x Rp1/2"	41	22	32	18	41	1/2"	29	41	22	32	18	24	DN20	1/2" (DN15)	DN20	11903
22 x 22mm x Rp3/4"	41	22	32	18	41	3/4"	28	41	22	32	18	30	DN20	3/4" (DN20)	DN20	11904
28 x 28mm x Rp1/2"	46	28	38	22	44	1/2"	32	46	28	38	22	24	DN25	1/2" (DN15)	DN25	11905
28 x 28mm x Rp3/4"	46	28	38	22	45	3/4"	32	46	28	38	22	30	DN25	3/4" (DN20)	DN25	11906
35 x 35mm x Rp1/2"	46	28	38	22	44	1/2"	32	46	28	38	22	24	DN25	1/2" (DN15)	DN25	11907
35 x 35mm x Rp3/4"	51	35	45	24	48	3/4"	35	51	35	45	24	30	DN32	3/4" (DN20)	DN32	11908
42 x 42mm x Rp1/2"	59	42	54	27	46	1/2"	34	59	42	54	27	24	DN40	1/2" (DN15)	DN40	11909
54 x 54mm x Rp1/2"	71	54	65	34	55	1/2"	43	71	54	65	34	30	DN50	1/2" (DN15)	DN50	11910
54 x 54mm x Rp3/4"	71	54	65	34	69	3/4"	47	71	54	65	34	24	DN50	3/4" (DN20)	DN50	11911
54 x 54mm x Rp2"	71	54	65	34	58	2"	45	71	54	65	34	65	DN50	2" (DN50)	DN50	11912
76.1 x 76.1mm x Rp3/4"	116	76	94	61	81	3/4"	-	116	76	94	59	30	DN65	3/4" (DN20)	DN65	20551
76.1 x 76.1mm x Rp2"	116	76	94	61	68	2"	-	116	76	94	55	65	DN65	2" (DN50)	DN65	20552
88.9 x 88.9mm x Rp3/4"	131	89	109	68	88	3/4"	-	131	89	109	66	30	DN80	3/4" (DN20)	DN80	20553
88.9 x 88.9mm x Rp2"	131	89	109	68	87	2"	-	131	89	109	74	65	DN80	2" (DN50)	DN80	20554
108 x 108mm x Rp3/4"	156	108	133	79	86	3/4"	-	156	108	133	73	30	DN100	3/4" (DN20)	DN100	20555
108 x 108mm x Rp2"	156	108	133	79	98	2"	-	156	108	133	76	65	DN100	2" (DN50)	DN100	20556



## SSG61/7301 Stop end

Press

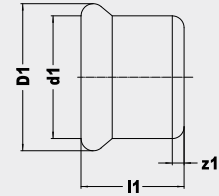

Size	l1	d1	D1	z1	DN1	Code
15mm	37	15	23	16	DN12	11980
22mm	41	22	32	18	DN20	11982
28mm	46	28	38	22	DN25	11983
35mm	51	35	45	24	DN32	11984
42mm	59	42	54	27	DN40	11985
54mm	72	54	65	35	DN50	11986



### SR1/7270 Straight coupling

Press x press

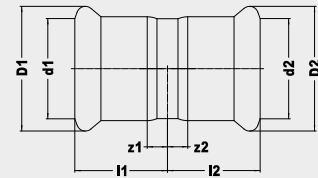

Size	l1	d1	D1	z1	l2	d2	D2	z2	DN1	DN2	Code
15mm	22	15	23	2	22	15	23	2	DN12	DN12	38010R
22mm	23	22	31	2	23	22	31	2	DN20	DN20	38020R
28mm	25	28	37	2	25	28	37	2	DN32	DN32	38030R
35mm	28	35	44	2	28	35	44	2	DN32	DN32	38032R
42mm	36	42	53	4	36	42	53	4	DN40	DN40	38034R
54mm	42	54	65	5	42	54	65	5	DN50	DN50	38035R

### SR1 Slip/7270S Straight coupling slip pattern

Press x press (without tube stop)

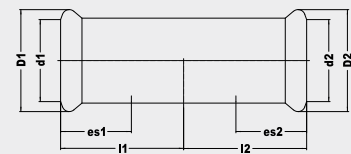

Size	l1	d1	D1	z1	l2	d2	D2	z2	DN1	DN2	Code
15mm	40	15	23	20	40	15	23	20	DN12	DN12	38044R
22mm	42	22	31	21	42	22	31	21	DN20	DN20	38045R
28mm	46	28	37	23	46	28	37	23	DN25	DN25	38046R
35mm	50	35	44	25	50	35	44	25	DN32	DN32	38047R
42mm	60	42	53	30	60	42	53	30	DN40	DN40	38048R
54mm	71	54	65	35	71	54	65	35	DN50	DN50	38049R

### SR2/6270G Straight female connector

Press x BSP parallel female thread

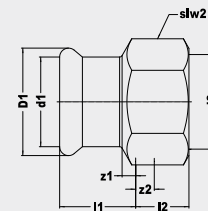

Size	l1	d1	D1	z1	l2	z2	slw2	sks2	DN1	DN2	Code
15mm x Rp1/2"	19	15	23	2	18	8	25	29	DN12	1/2" (DN15)	38090R
22mm x Rp3/4"	20	22	31	1	19	9	30	32	DN20	1" (DN25)	38092R
28mm x Rp1"	23	28	37	1	22	10	37	39	DN25	3/4" (DN20)	38093R
35mm x Rp1 1/4"	25	35	44	1	25	11	46	49	DN32	1" (DN25)	38094R
42mm x Rp1 1/2"	27	42	53	1	25	11	48	56	DN40	1 1/4" (DN32)	38095R
54mm x Rp2"	32	54	65	1	25	11	48	56	DN50	1 1/4" (DN32)	38096R

## FEATURES

✚ Leak Before Press (LBP) technology identifies joints that have not been pressed correctly in sizes 15mm-54mm

✚ Designed for solar installations where extreme temperatures operate as low as -20°C to a maximum 200°C

✚ Heat free jointing provides time and cost saving benefits to contractors/installers

### SR3/6243G Straight male connector

Press x BSP taper male thread

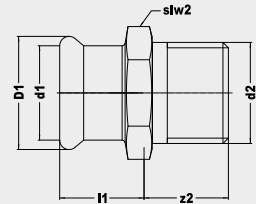

Size	l1	d1	D1	z1	l2	z2	slw2	sks2	DN1	DN2	Code
15mm x R1/2"	20	15	23	4	17	8	21	24	DN12	1/2" (DN15)	38114R
22mm x R3/4"	21	22	31	5	19	10	30	32	DN20	3/4" (DN20)	38116R
28mm x R1"	23	28	37	5	10	11	36	38	DN25	1" (DN25)	38118R
35mm x R1 1/4"	26	35	44	5	22	15	41	44	DN32	1 1/4" (DN32)	38119R
42mm x R1 1/2"	30	42	53	2	28	16	51	53	DN40	1 1/2" (DN40)	38120R
54mm x R2"	35	54	65	7	28	12	-	66	DN50	2" (DN50)	38121R

### SR6/7243 Reducer

Larger male end for insertion into a fitting x press

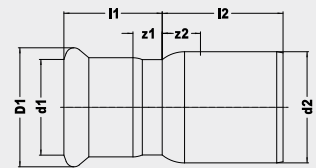

Size	l1	d1	D1	z1	l2	d2	z2	DN1	DN2	Code
22 x 15mm	24	15	23	4	23	22	3	DN12	DN20	38200R
28 x 15mm	25	15	23	4	37	28	14	DN12	DN25	38202R
28 x 22mm	25	22	31	4	30	28	7	DN20	DN25	38204R
35 x 22mm	29	22	31	9	39	35	13	DN20	DN32	38207R
35 x 28mm	28	28	37	5	35	35	9	DN25	DN32	38208R
42 x 22mm	25	22	31	4	49	42	19	DN20	DN40	38210R
42 x 28mm	27	28	37	4	44	42	14	DN25	DN40	38211R
42 x 35mm	35	35	44	8	38	42	8	DN32	DN40	38212R
54 x 28mm	27	28	37	4	59	54	24	DN25	DN50	38215R
54 x 35mm	35	35	44	9	53	54	18	DN32	DN50	38216R
54 x 42mm	40	42	53	9	47	54	12	DN40	DN50	38217R



### SR11/S6330 Union coupling

Press x press

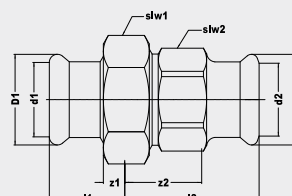

Size	l1	d1	D1	z1	slw1	sks1	l2	d2	D2	z2	slw2	sks2	DN1	DN2	Code
15mm	27	15	23	7	30	34	33	15	23	13	25	27	DN12	DN12	38180R
22mm	31	22	31	10	36	41	37	22	31	16	32	34	DN20	DN20	38181R
28mm	33	28	37	10	46	49	41	28	37	16	40	42	DN25	DN25	38182R
35mm	33	35	44	10	52	56	38	35	44	17	46	46	DN32	DN32	38183R
42mm	41	42	53	7	58	61	50	42	53	14	51	54	DN40	DN40	38184R
54mm	48	54	65	11	75	79	51	54	65	20	65	70	DN50	DN50	38185R

### SR12/7002A Elbow

Press x press

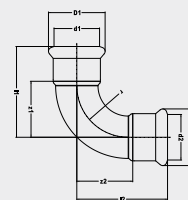

Size	l1	d1	D1	z1	l2	d2	D2	z2	DN1	DN2	Code
15mm	38	15	23	17	38	15	23	17	DN12	DN12	38280R
22mm	42	18	26	22	42	18	26	22	DN15	DN15	38290R
28mm	47	22	31	26	47	22	31	26	DN20	DN20	38300R
35mm	56	28	37	34	56	28	37	34	DN25	DN25	38302R
42mm	68	35	44	42	68	35	44	42	DN32	DN32	38304R
54mm	80	42	53	50	80	42	53	50	DN40	DN40	38306R

### SR12S/7001A Street elbow

Press x male end for insertion into a fitting

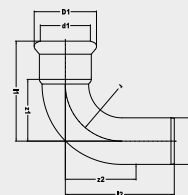

Size	l1	d1	D1	z1	l2	d2	DN1	DN2	Code
15mm	36	15	23	16	50	15	DN12	DN12	38318R
22mm	47	22	31	27	58	22	DN20	DN20	38320R
28mm	58	28	37	34	64	28	DN25	DN25	38322R
35mm	69	35	44	44	82	35	DN32	DN32	38324R
42mm	81	42	53	52	101	42	DN40	DN40	38325R
54mm	100	54	65	66	120	54	DN50	DN50	38326R



### SR13/6092G Male elbow

Press x BSP taper male thread

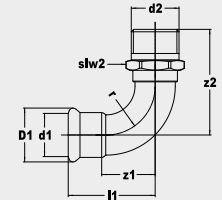

Size	l1	d1	D1	z1	slw2	l2	z2	DN1	DN2	Code
15mm x R1/2"	38	15	23	19	-	34	26	DN12	1/2" (DN15)	38333R
22mm x R3/4"	47	22	31	28	-	43	34	DN20	3/4" (DN20)	38334R
28mm x R1"	58	28	37	36	-	53	43	DN25	1" (DN25)	38335R
35mm x R1 1/4"	55	35	44	30	-	47	34	DN32	1 1/4" (DN32)	38336R
42mm x R1 1/2"	62	42	53	32	-	51	38	DN40	1 1/2" (DN40)	38337R
54mm x R2"	70	54	65	35	65	63	47	DN50	2" (DN50)	38338R

### SR14/6090G Female elbow

Press x BSP parallel female thread

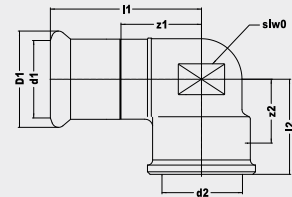

Size	l1	d1	D1	z1	slw0	l2	z2	DN1	DN2	Code
15mm x Rp1/2"	48	15	23	28	-	23	12	DN12	1/2" (DN15)	38351R
22mm x Rp3/4"	45	22	31	24	25	27	11	DN20	3/4" (DN20)	38353R
28mm x Rp1"	51	28	37	28	33	33	14	DN25	1" (DN25)	38354R
35mm x Rp1 1/4"	55	35	44	29	46	45	21	DN32	1 1/4" (DN32)	38355R
42mm x Rp1 1/2"	63	42	53	35	46	52	26	DN40	1 1/2" (DN40)	38356R
54mm x Rp2"	74	54	65	42	65	60	33	DN50	2" (DN50)	38357R

### SR15/6472G Backplate elbow

Press x BSP parallel female thread

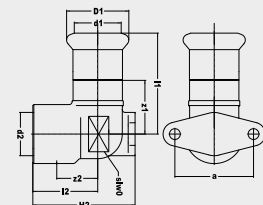

Size	l1	d1	D1	z1	l2	z2	DN1	DN2	Code
15mm x 1/2"	48	15	23	28	19	8	DN12	1/2" (DN15)	38400R
22mm x 3/4"	45	22	31	24	27	11	DN20	3/4" (DN20)	38401R



### SR21/7041 Obtuse elbow

Press x press

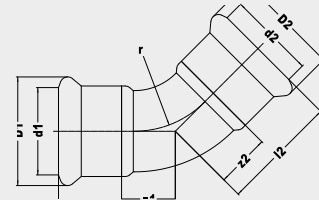

Size	l1	d1	D1	z1	l2	d2	D2	z2	DN1	DN2	Code
15mm	28	15	23	8	28	15	23	8	DN12	DN12	38410R
22mm	31	22	31	12	31	22	31	12	DN20	DN20	38412R
28mm	37	28	37	16	37	28	37	16	DN25	DN25	38414R
35mm	44	35	44	18	44	35	44	18	DN32	DN32	38416R
42mm	51	42	53	21	51	42	53	21	DN40	DN40	38417R
54mm	62	54	65	27	62	54	65	27	DN50	DN50	38418R

### SR21S/7040 Obtuse street elbow

Press x male end for insertion into a fitting

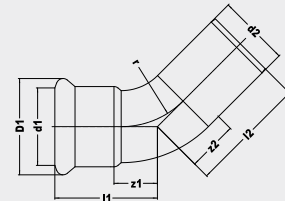

Size	l1	d1	D1	z1	l2	d2	z2	DN1	DN2	Code
15mm	28	15	23	8	37	15	17	DN12	DN12	38404R
22mm	32	22	31	11	44	22	23	DN20	DN20	38405R
28mm	37	28	37	14	47	28	24	DN25	DN25	38406R
35mm	43	35	44	17	58	35	32	DN32	DN32	38407R
42mm	51	42	53	21	71	42	41	DN40	DN40	38408R
54mm	62	54	65	27	82	54	47	DN50	DN50	38409R

### SR24/7130 Equal tee

Press on all ends

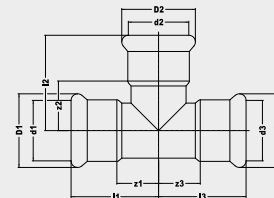
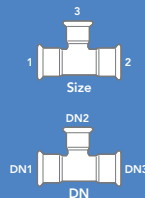

Size	l1	d1	D1	z1	l2	d2	D2	z2	l3	d3	D3	z3	DN1	DN2	Code
15mm	32	15	23	12	32	15	23	12	32	15	23	12	DN12	DN12	38450R
22mm	37	22	31	16	37	22	31	16	37	22	31	16	DN20	DN20	38460R
28mm	42	28	37	19	42	28	37	19	42	28	37	19	DN25	DN25	38462R
35mm	50	35	44	24	50	35	44	24	50	35	44	24	DN32	DN32	38464R
42mm	58	42	53	28	58	42	53	28	58	42	53	28	DN40	DN40	38466R
54mm	69	54	65	34	69	54	65	34	69	54	65	34	DN50	DN50	38467R



## SR25/7130 Tee, reduced branch

Press on all ends

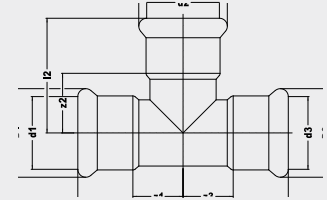
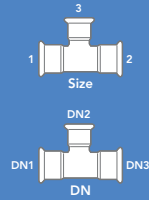

Size	l1	d1	D1	z1	l2	d2	D2	z2	l3	d3	D3	z3	DN1	DN2	DN3	Code
22 x 22 x 15mm	37	22	31	16	38	15	23	18	37	22	31	16	DN20	DN12	DN20	38490R
28 x 28 x 15mm	42	28	37	19	41	15	23	21	42	28	37	19	DN25	DN12	DN25	38492R
28 x 28 x 22mm	42	28	37	19	41	22	31	20	42	28	37	19	DN25	DN20	DN25	38494R
35 x 35 x 15mm	45	35	44	19	44	15	23	24	45	35	44	19	DN32	DN12	DN32	38496R
35 x 35 x 22mm	45	35	44	19	45	22	31	24	45	35	44	19	DN32	DN20	DN32	38497R
35 x 35 x 28mm	50	35	44	24	44	28	37	21	50	35	44	24	DN32	DN25	DN32	38498R
42 x 42 x 15mm	50	42	53	20	48	15	23	28	50	42	53	20	DN40	DN12	DN40	38499R
42 x 42 x 22mm	50	42	53	20	48	22	31	27	50	42	53	20	DN40	DN20	DN40	38500R
42 x 42 x 28mm	56	42	53	26	49	28	37	26	56	42	53	26	DN40	DN25	DN40	38501R
42 x 42 x 35mm	56	42	53	26	50	35	44	24	56	42	53	26	DN40	DN32	DN40	38502R
54 x 54 x 22mm	60	54	65	25	54	22	31	33	60	54	65	25	DN50	DN20	DN50	38504R
54 x 54 x 28mm	60	54	65	25	55	28	37	32	60	54	65	25	DN50	DN25	DN50	38505R
54 x 54 x 35mm	61	54	65	24	55	35	44	29	61	54	65	24	DN50	DN32	DN50	38506R
54 x 54 x 42mm	69	54	65	34	64	42	53	34	69	54	65	34	DN50	DN40	DN50	38507R

## SR26/7130 Tee, one end reduced

Press on all ends

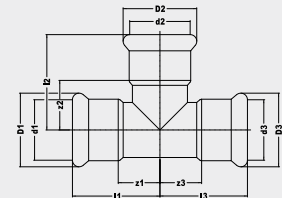
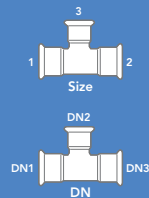

Size	l1	d1	D1	z1	l2	d2	D2	z2	l3	d3	D3	z3	DN1	DN2	DN3	Code
22 x 15 x 22mm	37	22	31	16	37	22	31	16	46	15	23	26	DN20	DN20	DN12	38510R
28 x 15 x 28mm	42	28	37	19	42	28	37	19	55	15	23	35	DN25	DN25	DN12	38512R
28 x 22 x 28mm	42	35	44	19	42	35	44	19	52	22	31	31	DN32	DN32	DN20	38514R
35 x 22 x 35mm	51	35	44	25	50	35	44	24	72	22	31	51	DN32	DN32	DN20	38517R
35 x 28 x 35mm	51	35	44	25	50	35	44	24	67	28	37	41	DN32	DN32	DN25	38518R



### SR27/7130 Tee, one end and branch reduced

Press on all ends

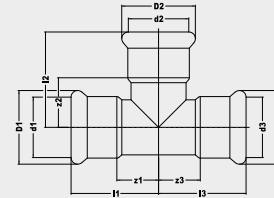
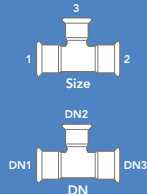

Size	l1	d1	D1	z1	l2	d2	D2	z2	l3	d3	D3	z3	DN1	DN2	DN3	Code
22 x 15 x 15mm	37	22	31	16	44	15	23	18	43	15	23	23	DN20	DN12	DN12	38530R
28 x 22 x 15mm	42	28	37	19	41	15	23	21	46	22	31	25	DN25	DN12	DN20	38536R
28 x 22 x 22mm	42	28	37	19	41	22	31	20	49	22	31	28	DN25	DN20	DN20	38532R
35 x 22 x 22mm	51	35	44	25	44	22	31	23	67	22	31	45	DN32	DN20	DN20	38539R
35 x 28 x 22mm	51	35	44	25	44	22	31	23	63	28	37	40	DN32	DN20	DN25	38541R
35 x 28 x 28mm	51	35	44	25	44	28	37	21	67	28	37	44	DN32	DN25	DN25	38542R

### SR28/7130 Tee, both ends reduced

Press on all ends

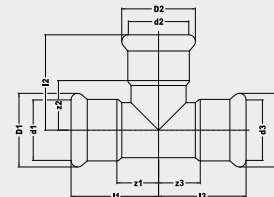
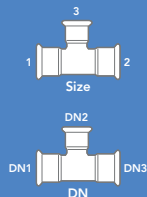

Size	l1	d1	D1	z1	l2	d2	D2	z2	l3	d3	D3	z3	DN1	DN2	DN3	Code
15 x 15 x 22mm	38	15	23	18	34	15	23	13	23	15	23	38	DN12	DN20	DN12	38545R

### SR30/6130G Female branch tee

Press x BSP parallel female branch

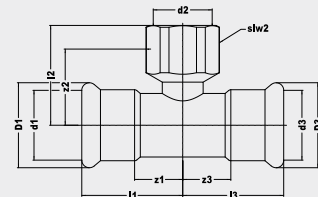
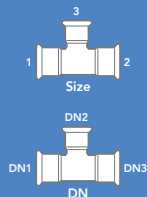

Size	l1	d1	D1	z1	l2	z2	slw2	sks2	l3	d3	D3	z3	DN1	DN2	DN3	Code
15 x 15mm x Rp1/2"	48	15	23	28	24	13	26	28	48	15	23	28	DN12	1/2" (DN15)	DN12	38585R
22 x 22mm x Rp1/2"	42	22	31	21	26	11	26	28	42	22	31	21	DN20	1/2" (DN15)	DN20	38591R
22 x 22mm x Rp3/4"	45	22	31	24	27	11	32	34	45	22	31	24	DN20	3/4" (DN20)	DN20	38587R
28 x 28mm x Rp1/2"	44	28	37	21	29	14	26	-	44	28	37	21	DN25	1/2" (DN15)	DN25	38592R
28 x 28mm x Rp3/4"	41	28	37	18	34	14	32	-	41	28	37	18	DN25	3/4" (DN20)	DN25	38593R
35 x 35mm x Rp1/2"	50	35	44	24	34	19	26	-	50	35	44	24	DN32	1/2" (DN15)	DN32	38594R
42 x 42mm x Rp1/2"	57	42	53	27	38	23	26	-	57	42	53	27	DN40	1/2" (DN15)	DN40	38596R



### SR61/7301 Stop end

Press for copper tube

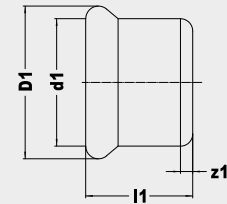

Size	l1	d1	D1	z1	DN1	Code
15mm	20	15	23	2	DN12	38695R
22mm	21	22	31	2	DN20	38697R
28mm	23	28	37	2	DN25	38698R
35mm	26	35	44	2	DN32	38699R
42mm	30	42	53	2	DN40	38700R
54mm	35	54	65	2	DN50	38701R

### SR69/6331G Straight male union connector

Press x BSP taper male thread

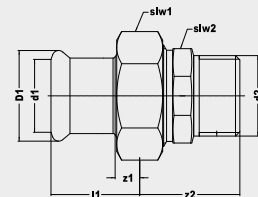

Size	l1	d1	D1	z1	slw1	sks1	l2	z2	slw2	sks2	DN1	DN2	Code
15mm x R1/2"	30	15	23	10	30	34	32	24	25	27	DN12	1/2" (DN15)	38813R
22mm x R3/4"	36	22	31	15	36	41	38	28	32	34	DN20	3/4" (DN20)	38814R
28mm x R1"	36	28	37	13	46	50	40	30	40	42	DN25	1" (DN25)	38816R
35mm x R1 1/4"	36	35	44	10	52	56	43	24	46	48	DN32	1 1/4" (DN32)	38817R
42mm x R1 1/2"	44	42	53	14	58	61	44	31	51	54	DN40	1 1/2" (DN40)	38818R
54mm x R2"	52	54	65	17	75	79	49	33	65	70	DN50	2" (DN50)	38819R

### SR69F/6330G Straight female union connector

Press x BSP parallel female thread

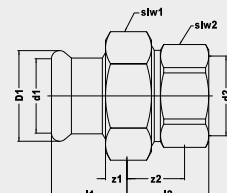

Size	l1	d1	D1	z1	slw1	sks1	l2	z2	slw2	sks2	DN1	DN2	Code
15mm x Rp1/2"	30	15	23	10	30	34	22	7	26	27	DN12	1/2" (DN15)	38833R
22mm x Rp3/4"	36	22	31	14	36	41	32	15	39	40	DN20	1" (DN25)	38834R
28mm x Rp1"	36	28	37	13	46	50	29	10	43	45	DN25	1" (DN25)	38835R
35mm x Rp1 1/4"	36	35	44	9	52	56	38	17	48	50	DN32	1 1/4" (DN32)	38836R
42mm x Rp1 1/2"	44	42	53	14	58	61	39	18	54	57	DN40	1 1/2" (DN40)	38837R
54mm x Rp2"	52	54	65	17	75	79	38	12	65	70	DN50	2" (DN50)	38838R



### S105S Flat face union rubber washer (Mk1)

For use with XPress stainless and XPress carbon union fittings



Size	Code
2"	27044
2 1/2"	27045

### SS106 Flat face union rubber washer (Mk2)

For use with XPress unions stainless and carbon steel only



Size	Code
15 - 18mm	27030
22mm	27031
28mm	27032
35mm	27033
42mm	27034
54mm	27035

### S104 Flat face union fibre washer (Mk1)

For use with XPress unions (not suitable for stainless steel)



Size	Code
1/2"	38989
3/4"	38990
1"	38891
1 1/4"	38892
1 1/2"	38893
2"	38894
2 1/2"	38895

\*If in doubt when ordering replacement washers, please contact the Pegler Yorkshire Sales Office.

### S100 Replacement O rings

For use on XPress copper fittings only



Size	Code
12mm	39116
15mm	39115
18mm	39117
22mm	39122
28mm	39128
35mm	39135
42mm	39142
54mm	39154
66.7mm	39230
76.1mm	39231
108mm	39232

### SS100 Replacement O rings

For use on XPress stainless and carbon fittings only



Size	Code
15mm	27000
18mm	27001
22mm	27002
28mm	27003
35mm	27004
42mm	27005
54mm	27006
76.1mm	27007
88.9mm	27008
108mm	27009

### SV100 Viton O rings

For use on XPress copper and XPress solar fittings



Size	Code
12mm	39098
15mm	39100
18mm	39099
22mm	39101
28mm	39102
35mm	39103
42mm	39104
54mm	39105

\*If in doubt when ordering replacement washers, please contact the Pegler Yorkshire Sales Office.

### SV105 Viton O rings

For use on XPress stainless and XPress carbon fittings only



Size	Code
15mm	27000
18mm	27001
22mm	27002
28mm	27003
35mm	27004
42mm	27005
54mm	27006
76.1mm	27007
88.9mm	27008
108mm	27009

\*\*Not applicable to stainless steel.



**SS110**  
**Depth gauge**  
Suitable for copper



Size	Code
12 - 108mm	39173

**S122**  
**Copper tube preparation kit**



Size	Code
35 - 54mm	39233

**TC146**  
**Rotodrive holder**  
For use with TC145/148



Size	Code
-	76203

**SS111**  
**Depth gauge**  
Suitable for carbon and stainless steel



Size	Code
12 - 108mm	39174

**S135**  
**Dri-slide lubricant**  
For use with jaws and slings only



Size	Code
115ml	36169

**TC147**  
**Noga 1000**  
For use with TC143/144



Size	Code
-	76208

**S130**  
**Silicone lubricant**



Size	Code
100g tub	39219

**TC143**  
**Internal swivel blade**  
Cobalt - for use with TC147



Size	Code
All tube sizes	76200

**TC148**  
**Noga 3000**  
For use with TC145/146



Size	Code
-	76206

**S115**  
**Tube stripper**  
For use with SC660 tube



Size	Code
15mm	39260
18mm	39261
22mm	39262
28mm	39263
35 - 54mm	39264

**TC144**  
**Internal swivel blade**  
Carbide - BS 2015  
For use with TC147



Size	Code
All tube sizes	76201

**TC150**  
**Noga deburring kit**  
Contains TC148/146/145



Size	Code
15 - 22mm	76207

**S120**  
**Deburring tool**



Size	Code
12 - 54mm	39168

**TC145**  
**External chamfer bit**  
For use with TC146/148



Size	Code
15 - 22mm	76202



Pegler Yorkshire recommends the preferred XPress branded tooling for jointing XPress fitting Systems utilising the XPress Slings, Jaws and Tools. New and improved, they provide greater performance whilst being lighter and easier to handle. Incorporating an 'X' symbol, they provide an instant visual aid indicating the joint has been pressed using the preferred XPress tooling. The maintenance of tooling is critical to the joint integrity, therefore the installer should ensure the tools are maintained in accordance with the manufacturer's instructions and serviced by a recommended tool-hire service centre.

#### S210 ACO102 ▲

	<b>Power</b>	<b>Charging Time</b>	<b>Piston Force</b>	<b>Piston Stroke</b>	<b>Item Code</b>
	Battery 12V UPCR Li-Ion 1.5/3.0Ah	60 min	Max. 19kN	30mm	39195
	<b>Tube/Pipe: Copper</b>	<b>Tube/Pipe: Steel</b>	<b>Tool Dimensions</b>		<b>Other</b>
	12-35mm	15-35mm	350 x 62 x 80mm 1.7Kg		LED display for battery status and press error indicator
	<b>Compatible with XPress Systems</b>			<b>Contains</b>	
Copper, Carbon Steel, Stainless Steel, Copper Gas, Stainless Steel Gas and Solar			S210 ACO102, 2 x Batteries, Battery Charger Carry Case 480 x 350 x 110mm Total Weight: 4.1Kg		

#### S225 ECO202 ■

	<b>Power</b>	<b>Piston Force</b>	<b>Piston Stroke</b>	<b>Item Code</b>	
	Mains 110V, 450W	Max. 32kN	40mm	39244	
	<b>Tube/Pipe: Copper</b>	<b>Tube/Pipe: Steel</b>	<b>Tool Dimensions</b>		<b>Other</b>
	12-54mm	15-54mm	430 x 75 x 111mm 3.9Kg		Visible electronic sensor for jaw locking bolt. Contains electronic log book for analysis
	<b>Compatible with XPress Systems</b>			<b>Contains</b>	
Copper, Carbon Steel, Stainless Steel, Copper Gas, Stainless Steel Gas and Solar			S225 ECO202 Carry Case 430 x 75 x 111mm Total Weight: 5.5Kg		

#### S226 ACO202 ■

	<b>Power</b>	<b>Charging Time</b>	<b>Piston Force</b>	<b>Piston Stroke</b>	<b>Item Code</b>
	Battery 18V Li-Ion 1.5/3.0Ah	60 min	Max. 32kN	40mm	39201
	<b>Tube/Pipe: Copper</b>	<b>Tube/Pipe: Steel</b>	<b>Tool Dimensions</b>		<b>Other</b>
	12-54mm	15-54mm	408 x 80 x 125mm 3.3Kg		Visible electronic sensor for jaw locking bolt. Contains electronic log book for analysis
	<b>Compatible with XPress Systems</b>			<b>Contains</b>	
Copper, Carbon Steel, Stainless Steel, Copper Gas, Stainless Steel Gas and Solar			S226 ACO202, 1 x Battery, Battery Charger, Carry Case 557 x 422 x 132mm Total Weight: 7.9Kg		



## S230 ACO202XL +

	<b>Power</b>	<b>Charging Time</b>	<b>Piston Force</b>	<b>Piston Stroke</b>	<b>Item Code</b>
	Battery 18V Li-Ion 1.5/3.0Ah	60 min	Max. 32kN	40 or 80mm	39285
	<b>Tube/Pipe: Copper</b>	<b>Tube/Pipe: Steel</b>	<b>Tool Dimensions</b>		<b>Other</b>
	12-108mm	12-108mm	487 x 79 x 116mm 4.6Kg		Visible electronic sensor for jaw locking bolt. Contains electronic log book for analysis
	<b>Compatible with XPress Systems</b>			<b>Contains</b>	
Copper, Carbon Steel, Stainless Steel, Copper Gas, Stainless Steel Gas and Solar			S230 ACO202XL, 2 x Batteries, Battery Charger, Carry Case 639 x 446 x 151mm Total Weight: 10.6Kg		

## S303 ECO301 ◆

	<b>Power</b>		<b>Piston Force</b>	<b>Piston Stroke</b>	<b>Item Code</b>
	Mains 110V, 560W		Max. 45kN	45mm	39199
	<b>Tube/Pipe: Copper</b>	<b>Tube/Pipe: Steel</b>	<b>Tool Dimensions</b>		<b>Other</b>
	12-108mm	12-108mm	420 x 85 x 110mm 5.0Kg		Fast pressing cycle for quick installation. Microprocessor driven for constant optimisation of pressing performance
	<b>Compatible with XPress Systems</b>			<b>Contains</b>	
Copper, Carbon Steel, Stainless Steel, Copper Gas, Stainless Steel Gas and Solar, Sprinkler ≤ 54mm Carbon Steel and Sprinkler ≤ 54mm Stainless Steel			S303 ECO301 Carry Case 639 x 466 x 151mm Total Weight: 12.3Kg		

## S400 ACO401 ●

	<b>Power</b>		<b>Piston Force</b>	<b>Piston Stroke</b>	<b>Item Code</b>
	Battery 18V Li-Ion		Max. 100kN	60mm	39267
	<b>Tube/Pipe: Copper</b>	<b>Tube/Pipe: Steel</b>	<b>Tool Dimensions</b>		<b>Other</b>
	Not Compatible	76.1 - 108mm	660 x 100 x 250mm 13.0Kg		Microprocessor driven for constant optimisation of pressing performance
	<b>Compatible with XPress Systems</b>			<b>Contains</b>	
Sprinkler; Carbon Steel and Sprinkler; Stainless Steel in sizes 76.1 – 108mm			S400 ACO401 Carry Case 630 x 130 x 465mm Total Weight: 25Kg		



For Jaw and Sling compatibility, please refer to the symbols given with the tool above - to the Jaws and Slings in the following tables:

<b>S211</b> <b>PB1 Jaws</b> Compatibility: ▲					
Size	a	b	c	Kg	Code
12mm	122	101	35	1	39191
15mm	122	101	35	1	39188
18mm	124	101	35	1	39189
22mm	126	101	35	1	39202
28mm	131	101	35	1	39203
35mm	143	101	35	1	39209

<b>S227</b> <b>ECOTEC PB2 Jaws</b> Compatibility: ■ +					
Size	a	b	c	Kg	Code
12mm	143	110	39	2	39179
15mm	143	110	39	2	39180
18mm	143	110	39	2	39181
22mm	147	110	39	2	39182
28mm	147	110	39	2	39183
35mm	154	110	39	2	39184

<b>S327</b> <b>ECO301 PB3 Jaws</b> Compatibility: ◆					
Size	a	b	c	Kg	Code
12mm	150	128	39	2	39194
15mm	150	128	39	2	39204
18mm	150	128	39	2	39205
22mm	154	127	39	2	39206
28mm	154	127	39	2	39207
35mm	163	129	39	2	39208

## 2.0 PRODUCT DETAILS

# XPRESS PRESS SLINGS



### S228 Snap on sling

Compatibility: ■ ◆ +

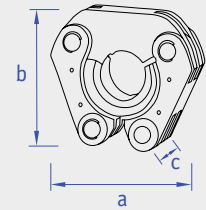

Size	a	b	c	Kg	Code
42mm	112	100	41	1	39186
54mm	124	112	41	2	39187

### S330 Snap on sling

Compatibility: ◆ +



66.7 - 8.9mm

108mm

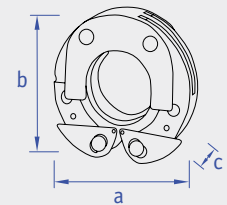

Size	a	b	c	Kg	Code
66.7mm	151	143	61	4	39220
76.1mm	164	155	61	4	39221
88.9mm	175	167	55	4	39224
108mm	209	205	77	6.3	39225

\*S330 in size 108mm is not suitable for copper, use S322

### S322 Sling (copper only)

Compatibility: ◆ +

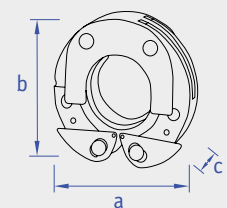

Size	a	b	c	Kg	Code
108mm	200	200	60	5	39222

### S410 HP Snap on sling 35mm

Not suitable for copper

Compatibility: ■ ◆ +

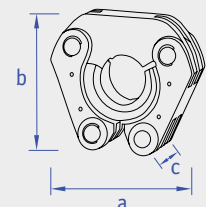

Size	a	b	c	Kg	Code
35mm	112	100	41	2	39268
42mm	125	120	41	2	39269
54mm	125	122	41	2	39271



#### S411-HP401 Snap on sling

Carbon and stainless only

Compatibility: ●

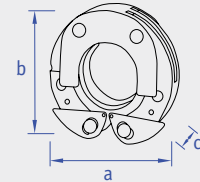

Size	a	b	c	Kg	Code
76.1mm	290	400	100	8	39273
88.9mm	290	400	100	8	39277
108mm	290	400	100	9	39279

#### S229 ZB203 Adaptor

Compatibility: ■

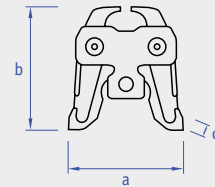

Size	a	b	c	Kg	Code
35-54mm	142	124	33	1	39190

#### S329 ZB303 Adaptor

Compatibility: ◆

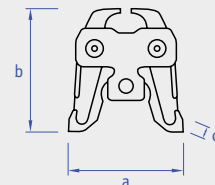

Size	a	b	c	Kg	Code
35-54mm	144	129	39	1	39227

#### S331 ZB323 Adaptor

Compatibility: ◆

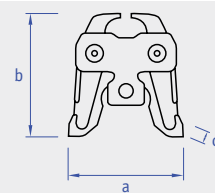

Size	a	b	c	Kg	Code
66.7-108mm	136	195	43	4	39213

#### S332 ZB324 Adaptor (2nd Press)

Compatibility: ◆

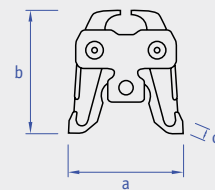

Size	a	b	c	Kg	Code
108mm	136	188	53	4	39214

## 2.0 PRODUCT DETAILS

# XPRESS PRESS ADAPTORS, BATTERIES AND CHARGERS



### S231 ZB221 Adaptor

Compatibility: +

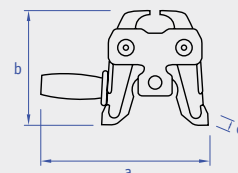

Size	a	b	c	Kg	Code
66.7-108mm	155	216	43	5	39286

### S232 ZB222 Adaptor (2nd press)

Compatibility: +

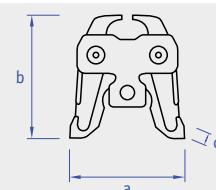

Size	a	b	c	Kg	Code
108mm	155	216	43	5	39287

All 108mm fittings, regardless of material, require a 2nd press using the respective adaptor, with the exclusion of the 5400 ACO401 as this is supplied with an internal adaptor.

## BATTERIES

### S340 ACO102 Battery

Compatibility: ▲

Size	Code
Li-Ion 12V 1.5Ah	39288
Li-Ion 12V 3Ah	39289

### S342 ACO202 Battery

Compatibility: ■ (39292)      Compatibility: ■ ● (39293)

Size	Code
18V 1.5Ah	39292
18V 3Ah	39293

### S344 AFP202 Battery

Novopress AFP202

Size	Code
Ni-Cd 14.4V 2Ah	39294
Li-Ion 18V 3Ah	39295

## CHARGERS

### S341 ACO102 Charger

Compatibility: ▲

Size	Code
12V (220-240v)	39290

### S343 ACO202/401 Charger

Compatibility: ■ ●

Size	Code
230V	39291

### S345 AFP202 Charger

Novopress AFP202

Size	Code
230V	39296



PRESS TOOLS APPROVED FOR PRESSING XPRESS						
Dimension (mm)	Manufacturer	Press Tool	Systems	Jaws (up to 35mm)	Sling Jaw adaptor (42mm and above)	Sling (Copper Stainless/Carbon)
12 - 35mm	REMS	REM-578012 Mini-Press ACC Battery powered (14.4V)	-	Mini M12 - M35*	-	-
1 - 54mm	REMS	REM-571013 Akku-Press Battery powered (14.4V)	-	M12 - M35*	Z2	M42 (PR-3S) M54 (PR-3S)
		REM-571014 Akku-Press ACC Battery powered (14.4V)	-	M12 - M35*	Z3	M42 (PR-3S) M54 (PR-3S)
		REM-577011 Power-Press	-	M12 - M35*	Z3	M42 (PR-3S) M54 (PR-3S)
		REM-572110 Power-Press E	-	M12 - M35*	Z3	M42 (PR-3S) M54 (PR-3S)
		REM-577010 Power-Press ACC	-	M12 - M35*	Z3	M42 (PR-3S) M54 (PR-3S)
12 - 28mm	Novopress	AFP101 Battery powered (9.6V)	-	PB1	-	-
		ACO102 Battery powered (12V)	-	PB1	-	-
12 - 54mm	Novopress	EFP2 (230V)	-	PB2 (ECOTEC)	ZB201/ZB203	35 (HP only) / 42 / 54**
		EFP201 / 202 / (230V)	-	PB2 (ECOTEC)	ZB201/ZB203	35 (HP only) / 42 / 54**
		AFP201 / 202 (14.4V)	-	PB2 (ECOTEC)	ZB201/ZB203	35 (HP only) / 42 / 54**
		ECO202	-	PB2 (ECOTEC)	ZB201/ZB203	35 (HP only) / 42 / 54**
		ACO202	-	PB2 (ECOTEC)	ZB201/ZB203	35 (HP only) / 42 / 54**
12 - 54mm	Novopress	ACO202XL	-	PB2 (ECOTEC)	ZB201/ZB203	35 (HP only) / 42 / 54**
		ECO301	-	PB3 (ECO301)	ZB201/ZB203/ZB303	35 (HP only) / 42 / 54**
66.7mm	Novopress	ACO202XL	-	-	ZB221	66.7mm Sling***
		ECO301	-	-	ZB323	66.7mm Sling***
76.1 - 108mm	Novopress	ACO202XL	-	-	ZB221	76.1 / 88.9 / 108
		ECO301	-	-	ZB323	76.1 / 88.9 / 108
108mm (2nd)	Novopress	ACO202XL	-	-	ZB222	Snap On Sling (Copper specific)
		ECO301	-	-	ZB324	Snap On Sling (Copper specific)
76.1 - 108mm	Novopress	ACO401	Carbon / Stainless / Sprinkler only	-	Integral adaptor on machine	HP401 Snap On Sling
15 - 54mm	Ridgid	RP 340	Not approved with Ridgid jaws - only with compatible Novopress / REMS jaws and slings			

\*For 18 and 28mm, only use jaws with marking '108' (Q1,2008) or '208' (Q2 2008) and higher

\*\*HP Snap On Sling for Stainless / Carbon applications only

\*\*\*See page 105 for guidance on pressing 66.7mm fittings

All 108mm fittings require a 2nd press using the respective adaptor. Copper uses a different 108mm sling for the 2nd press



**\*66.7mm (67mm) Sling (S330 Snap on sling)**

Novopress offers alternative slings for use on different press systems. As such Pegler Yorkshire reinforces the following instruction.

Where 66.7mm slings are required for crimping XPress fittings, installers must only use the following XPress/Novopress slings and adaptors:

Novopress Reference	Sling Marking	Novopress Adaptor
36516-50	"Woeste" 67mm	ZB302 42-66.7mm
45184-50	"XPress" 66.7mm	ZB323 66.7-108mm



Under no circumstances should any other brand of sling be used with our 66.7mm fittings as these will lead to an incorrect crimp resulting in an immediate joint failure and invalidate the Pegler Yorkshire warranty.

XPress 66.7mm fittings that have inadvertently been crimped with the wrong brand of sling cannot be successfully re-crimped with the XPress 66.7 sling and will unfortunately have to be cut out and replaced with a new fitting using the correct sling.

Note: Pegler Yorkshire 66.7mm will be referred to as 66.7mm and/or 67mm.

**POWER SUPPLY**

It is essential when preparing to undertake an installation using XPress fittings and tools that a suitable constant power source is available. If the supply of power is not constant it may affect the performance of the joint.

Checking the power source is particularly important prior to joining with the ECO202 and ECO301 tool as it includes safety software, which detects the amount of power available to the machine. If there is not enough for the tool to initiate the pressing cycle and complete a sound joint the tool will not commence the pressing operation. This feature is particularly useful when installing large size press fittings, as the pressure required to press these fittings is significantly greater than for smaller fittings, hence the power supply to the tool must be guaranteed.

It is therefore recommended that when using a portable transformer to provide power to the press tool, the transformer should be a minimum of 3KVA rated in order that a continuous uninterrupted power supply is always available.

When a semi-permanent source of power such as a generator is being used it is essential the plant is well maintained. The maximum cable size from generator to outlet and the minimum length of cable between the power outlet and the tool should be used.

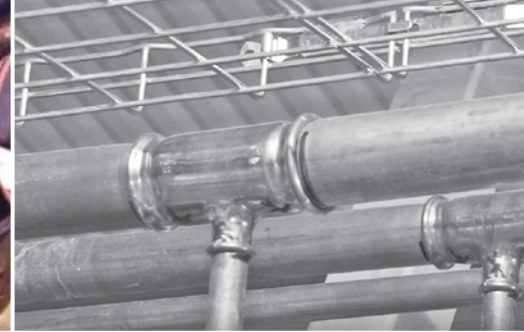

## 3.0 TECHNICAL DATA

### VALVES FOR THE XPRESS SYSTEM

The XPress range is supported by a comprehensive selection of adapted press-fit valves from Pegler Yorkshire's Ballorex and Pegler valve portfolios. The valves are available with standard XPress press-fit by XPress press-fit ends (PS) or XPress press-fit by XPress press union ends (PSU).

XPress press union ends provide an ideal break points that enables system maintenance and for equipment to be disconnected and reconnected for servicing.



#### BALLOREX Dynamic Valve (PICV)

For automatic balancing of sections of pipe work and equipment in HVAC applications. Dynamic PICV (Pressure Independent Control Valve) with direct flow measuring. Available in sizes 15mm to 18mm (PS) and 35mm to 54mm (PSU).



#### BALLOREX Fixed Orifice Commissioning Valve (FODRV)

For the isolation and balancing of sections of pipe work and equipment in HVAC applications. Valves can be double regulated and closed to a pre-selected value, set when commissioned. Available in sizes 15mm to 54mm (PS) and 15mm to 54mm (PSU) on both outlet or inlet. Alternatively Ballorex Venturi Commissioning valve (FODRV) are also available for maximum accuracy of +/-3%.



#### BALLOREX Circulation Valve

Enables the automatic thermal balancing and high temperature disinfection of hot water circulating systems, denying bacteria the optimum conditions for growth. Available in sizes 15mm to 28mm (PS and PSU).

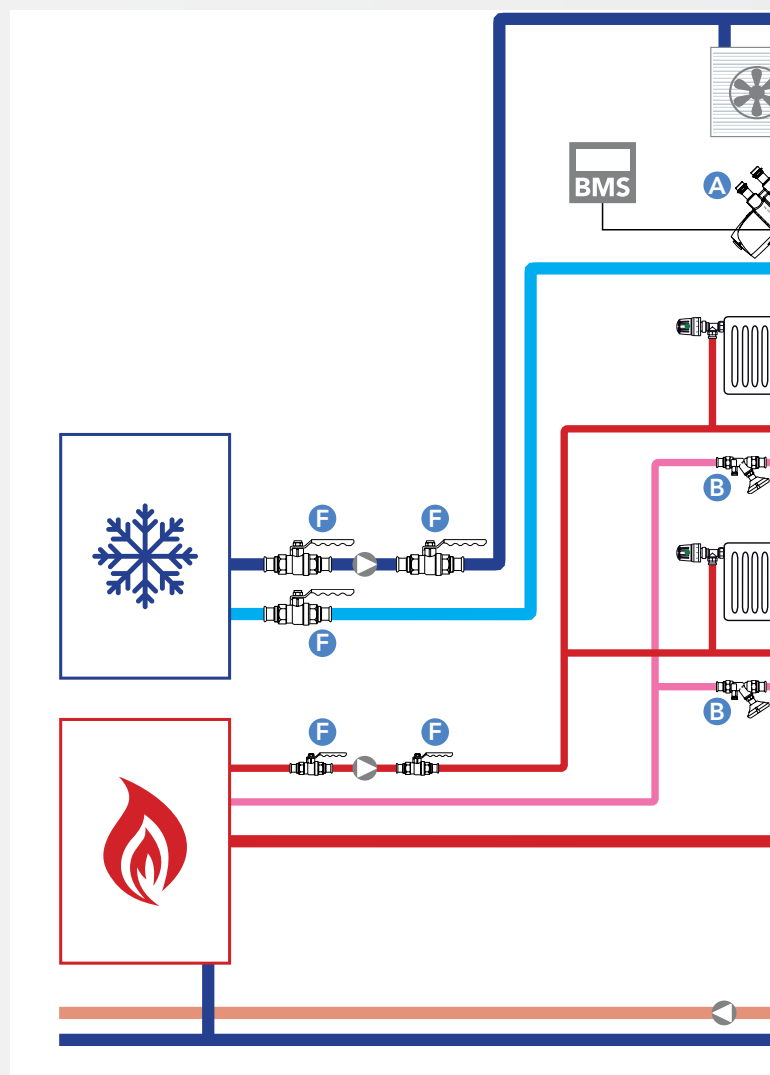

#### PEGLER Pressure Reducing Valve

Enables potentially damaging water pressures to be reduced. Adjustable 0.5 to 6.0 bar. Available in sizes 15mm to 54mm (PS) and 15mm to 28mm (PSU).



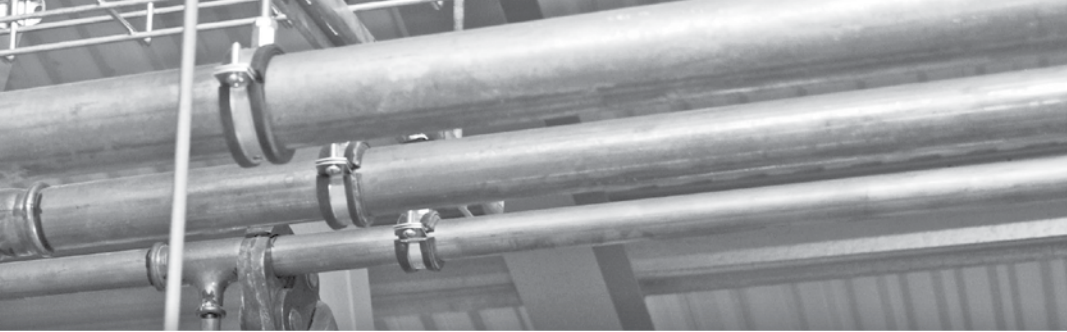

**CONNECT + CONTROL**

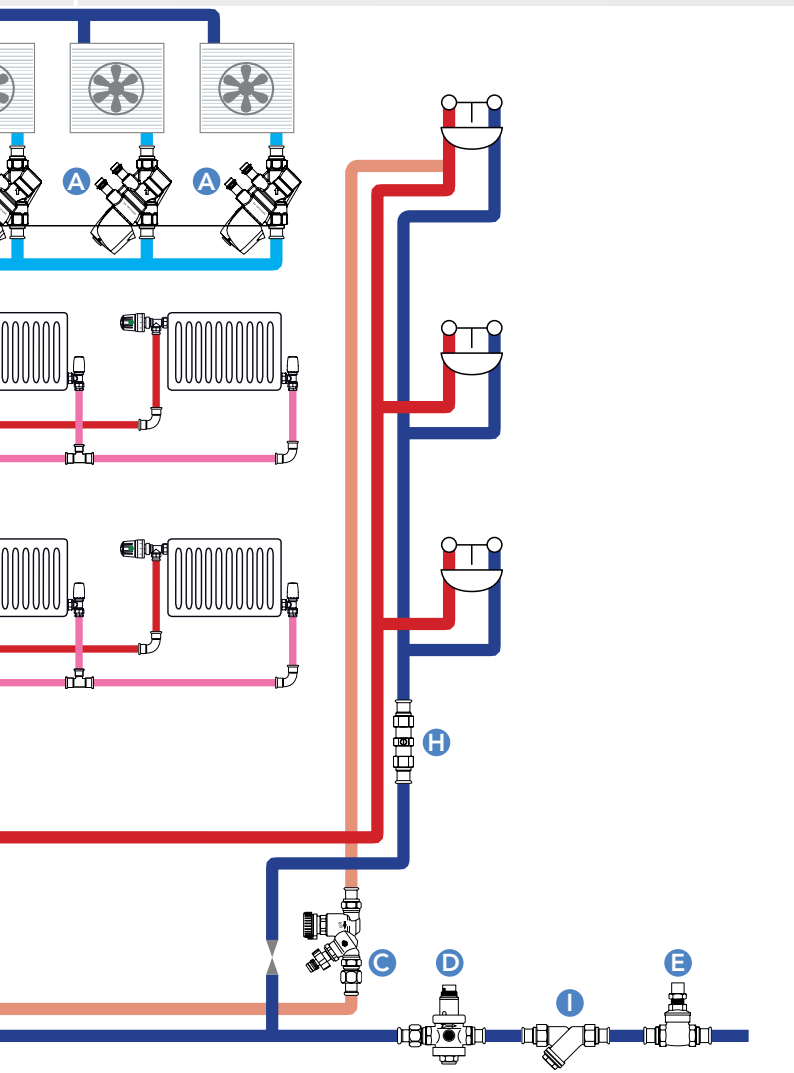

**PEGLER**  
**Quarter Turn Ball Valve**  
 Allow for the quick isolation of sections of pipe work and equipment. Available in Brass or DZR Brass in sizes 15mm to 54mm (PS and PSU).  
 The ball valve range are offered with lever, tee, extended stem and lockshield variations.

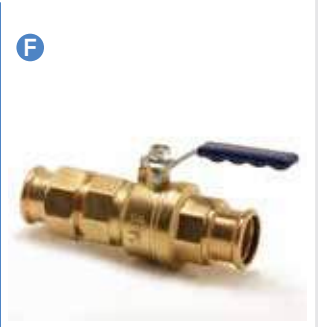

**PEGLER**  
**Bronze Y pattern strainer**  
 For the protection of equipment in pipe work systems. Available in 15mm to 54mm (PS and PSU).



**PEGLER**  
**Double check valve**  
 Prevent back flow and protect pipe work systems from contamination. Available in 15mm to 54mm (PS and PSU).  
 Pegler Bronze swing check valve are also available.

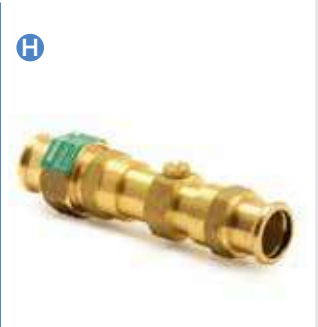

**PEGLER**  
**Gate Valve**  
 Allow for the isolation of sections of pipe work and equipment. Available in a range of valve body materials including Brass, DZR Brass and Bronze, in sizes 15mm to 54mm (PS and PSU) with wheel head and lockshield versions.



**XPress**  
**Flange**  
 A full range of XPress press-fit flanges provide compatibility to our range of large flanged valves that include Butterfly, Gate, Ball, Check valves and Strainers. Available in 66.7mm/DN65/2 1/2" to 108mm/DN100/4".





## 3.0 TECHNICAL DATA

# TUBE COMPATABILITY AND APPLICATIONS

FITTING AND TUBE COMPATABILITY							
Tube/pipe type	XPress Copper	XPress Chromium Plated	XPress Stainless	XPress Carbon	XPress Copper Gas	XPress Stainless Gas	XPress Solar
Copper tube**	✓	-	-	-	✓	-	✓
Chromium plated copper tube	-	✓	-	-	-	-	-
Stainless steel tube	-	-	✓	-	-	-	-
Carbon steel tube	-	-	✓*	✓	-	-	-
Plastic coated carbon steel tube	-	-	✓*	✓	-	-	-

It is advisable to make copper to steel connections via gunmetal/copper alloy fittings

\*Heating applications only. \*\*For XPress solar, copper tube with a maximum temperature of 200°C.

TYPICAL APPLICATIONS					
XPRESS COPPER	XPRESS STAINLESS	XPRESS CARBON	XPRESS COPPER GAS	XPRESS STAINLESS GAS	XPRESS SOLAR
Hot and cold water services	Potable water applications where water quality and hygiene are crucial	Vented and unvented closed circuit heating	Internal and external applications	Above ground 2nd and 3rd family gas service pipelines, including instances where high levels of hydrogen sulphide make copper unsuitable	Solar water heating systems
Vented and unvented closed circuit heating	Pharmaceutical, food and health-care environments	Chilled water applications	Above ground 2nd and 3rd family gas service pipeline		Synthetic oil-free compressed air
Chilled water and synthetic oil-free compressed air applications	Chilled water applications	Synthetic oil-free compressed air			
With chromium plated finish for surface mounted installations	Sprinkler System applications	Sprinkler System applications			

✚ For Fire Protection see XPress Sprinkler Data Book.

✚ Contact us for other applications.

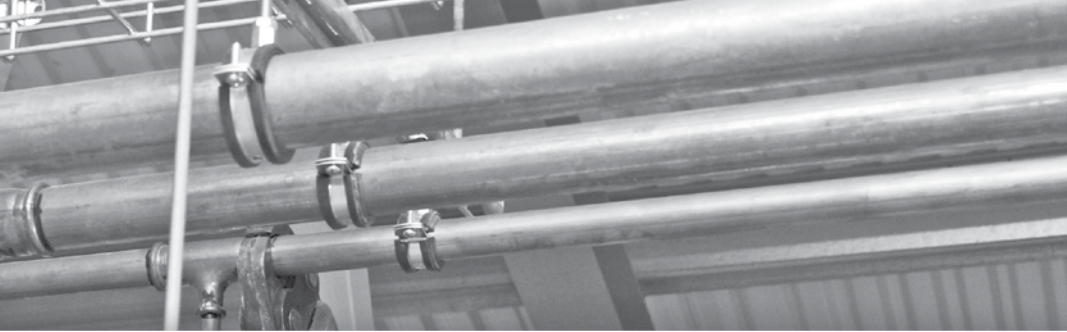

### 3.0 TECHNICAL DATA

## MATERIALS SPECIFICATION AND MANUFACTURING STANDARDS

CONNECT + CONTROL

MATERIALS SPECIFICATION			
Component	Body	O Ring	O Ring bead
<b>XPRESS COPPER</b>	Copper/Copper Alloy or Gunmetal Alloy	EPDM*	Copper
<b>XPRESS STAINLESS</b>	Stainless Steel (316L)	EPDM*	-
<b>XPRESS CARBON</b>	Carbon Steel ST34-2 (Nickel Plated)	EPDM*	-
<b>XPRESS COPPER GAS</b>	Copper/Copper Alloy or Gunmetal Alloy	Yellow HNBR†	-
<b>XPRESS STAINLESS GAS</b>	Stainless Steel (316L)	Yellow HNBR†	-
<b>XPRESS SOLAR</b>	Copper/Copper Alloy or Gunmetal Alloy	Green (FPM) (Viton™)	Copper

NB. O rings are supplied lubricated for easy tube insertion. \*Ethylene Propylene Diene Monomer. †Hydrogenated Acrylonitrile Butadiene Rubber.

MANUFACTURING STANDARDS								
Component	Standard	Summary	XPRESS COPPER	XPRESS STAINLESS	XPRESS CARBON	XPRESS COPPER GAS	XPRESS STAINLESS GAS	XPRESS SOLAR
Male end thread	ISO 7/EN10226-1 (formerly BS 21/ISO 7)	Pipe-threads, where pressure-tight joints are made on the threads (metric dimensions)	✓	✓	✓	✓	✓	✓
Female end thread	BS EN ISO 228:2003 (formerly BS 2779/ISO R228/1)	Pipe-threads, where pressure-tight joints are not made on the threads (metric dimensions)	✓	-	-	✓	-	✓
Female end thread	ISO 7/1 EN 10226-1	Pipe-threads, where pressure-tight joints are not made on the threads (metric dimensions)	-	✓	✓	-	✓	-

### CONNECTORS

#### Male Connectors

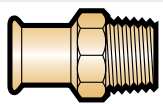

XPress male connectors have threads to BS 21/ISO 7 EN 10226-1. Inert jointing compounds or PTFE tape should be applied to taper threads.

PTFE tape should not be used in conjunction with stainless steel threads due to the water soluble chloride ions it contains.

XPress flat face unions are supplied with Fibre washer seals (XPress copper).

EPDM washer seals (XPress carbon and stainless).

#### Female Connectors

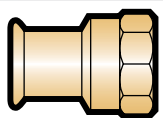

XPress female threaded connectors have internal parallel threads to ISO 7/EN 10226-1.

### TEE SPECIFICATION

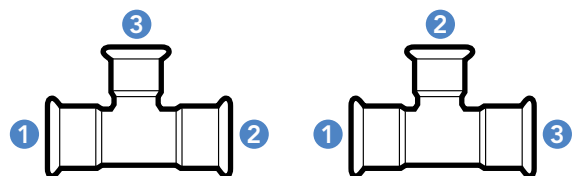

#### UK specification

First quote the ends on the run (larger end first) and then the branches

eg: 22 x 22 x 15

#### European specification

Quote the larger end first, then the branch, followed by the remaining end.

eg: 22 x 15 x 22

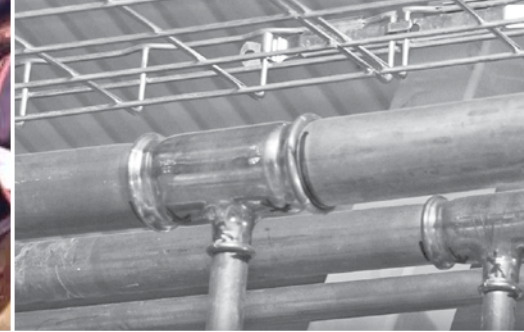

## 3.0 TECHNICAL DATA

# WORKING TEMPERATURES AND PRESSURE TABLES

XPress Copper fittings have all been tested and are suitable for use with approved tubes at temperatures from -20 to 110°C at a maximum working pressure of 16bar throughout the temperature range.

XPress Solar is approved with tube meeting the temperature rates shown in the table below and operates from -20 to 200°C at a maximum working pressure of 16bar, see exposure table on page 135.

XPress Stainless and XPress Carbon fittings have been tested and are suitable for use with approved tubes at temperatures from -35 to 135°C at a maximum working pressure of 16bar throughout the temperature range. For high working pressure applications contact the Pegler Yorkshire technical help desk.

XPress Copper Gas fittings are approved for use with copper tubes to BS EN 1057 at temperatures from -20 to 70°C and a maximum working pressure of 5bar for outside above ground pipework and 1bar within buildings.

As part of the DVGW/ BSI approvals process, XPress Gas fittings have passed the High Temperature Test at 650°C for 30 minutes at PN1 (copper)/PN5 (stainless).

### WET SYSTEM INSTALLATIONS

In wet system installations we recommend all systems be thoroughly tested upon completion. The installation may be tested to 1.5 times the working pressure of the system, up to a maximum of 16bar. If higher test pressures are required advice should be sought from Pegler Yorkshire.

### ACHIEVING LOW TEMPERATURES

For products used in water systems, working temperatures of less than 4°C can only be achieved if antifreeze is added to the system.

### LOCALISED ANNEALING OF COPPER TUBE

XPress Copper installation should not be carried out within 300mm of a brazed or

soldered joint, as the high temperature required for capillary jointing anneals the copper tube rendering it too soft for press-fit jointing. In an existing XPress Copper installation, brazing or soldering should not be carried out within 300mm of an existing press joint as this may damage the O ring.

Do not braze or weld XPress carbon or XPress stainless steel tubes.

### PRESSURE TESTING OF CARBON STEEL SYSTEMS

The following recommendations apply concerning the testing of XPress Carbon Steel.

Due to the potential for corrosion and perforation of carbon steel tube and fitting systems left partially drained for extended periods following hydraulic testing, it is recommended that XPress Carbon Steel systems be dry air/nitrogen tested, up to a maximum of 3bar.

If hydraulic testing must be undertaken the following should be considered.

- A.** The test water should contain anti-corrosion chemicals with the intention that post testing the system shall be left completely full of water (suitable protection against freezing will also have to be considered).
- B.** If leaving the system full of water is not practical then every effort shall be made to fully drain and dry the pipe work by purging with dry air.

Regarding the air/nitrogen testing of pipe work with XPress Carbon Steel crimped fittings the following points will need to be considered.

- 1.** The air should be clean, dry and free from oil. Excessive oil carried over in compressed air may be detrimental to the EPDM seals. This is not a problem with nitrogen.
- 2.** Air is many times more searching than water. Hence, if the purpose of the air test is only leak detection, then 0.5bar pressure will be more than sufficient. Higher pressures can in fact mask sealing

issues that would be revealed by low-pressure tests.

**3.** The need for higher test pressures to prove the mechanical integrity of the joints brings with it serious safety issues. Testing for such a failure mode with high-pressure air/nitrogen is potentially very dangerous as the energy stored in 5bar air/nitrogen, when released suddenly, could lead to damage to equipment or more seriously, injury to personnel. HSE issue guidelines for such testing should be strictly adhered to.

**4.** It is therefore recommended that an initial low pressure test at 0.5bar is carried out, having put the necessary safety measures in place, to enable any leaks to be found. Significantly leaking, un-pressed or damaged joints shall be replaced, but those with low leakage rates should be identified for close inspection during the high-pressure test. The full loading of the O rings often resolve small leaks identified during the 0.5bar test. When satisfied that the system is sound and having the necessary safety measures in place a 1.5 times working pressure test can be carried out as per the Copper Development Association (CDA) Guidelines document 'Pressure Testing Piping Systems'. Leaking joints at this stage should be identified and marked for replacement. The system pressure should then be reduced to 0.5bar again to confirm that no persistent low-pressure leaks are present.

**! NOTE: The maximum temperature and pressure range in any system is dictated by the component with the lowest performance rating.**

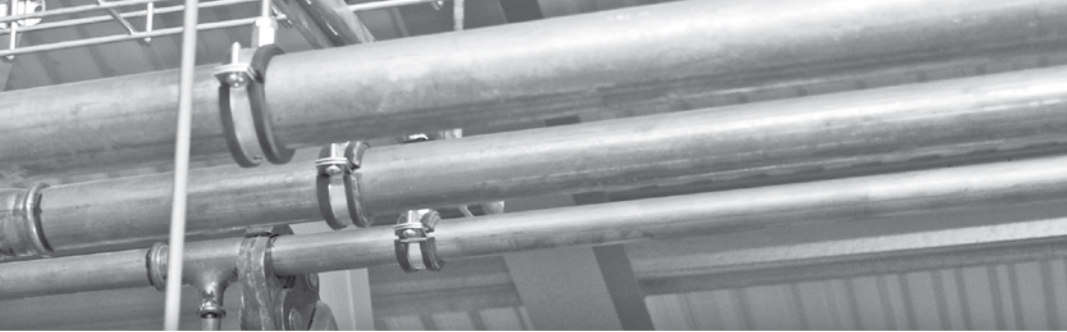

### PRESSURE EQUIPMENT DIRECTIVE

From 30th May 2002 most pressure equipment and assemblies on the market in the United Kingdom must comply with the Pressure Equipment Directive (PED) 1999. Fittings are exempt from the PED unless they are incorporated into pressure equipment falling within its scope. XPress valves are also exempt. For a detailed explanation please visit:

[www.pegleryorkshire.co.uk/technical.cfm](http://www.pegleryorkshire.co.uk/technical.cfm)

#### CE marking

CE marking is a manufacturers' declaration that their product complies with the essential requirements of all relevant European Directives and Regulations.

From 1 July 2013 manufacturers in Europe must comply with the Construction Products Regulations (EU) 305/2011. This regulation requires manufacturers to apply CE marking if their product is covered by a harmonised European Standard (hEN) or a European Technical Assessment (ETA).

At the time of going to print, there are currently no hENs or ETAs which apply to XPRESS, TECTITE, HENCO, YORKSHIRE, ENDEX, KUTERLITE, tube or fitting product ranges and consequently no requirement for CE marking. For more updated information please visit

[www.pegleryorkshire.co.uk](http://www.pegleryorkshire.co.uk)  
or [www.gov.uk/cemarking](http://www.gov.uk/cemarking)

### EQUIPOTENTIAL BONDING

It is the installers duty to ensure that all metallic pipework systems should comply with the equipotential bonding requirements of the current edition of the IEE electrical wiring regulations (BS 7671 1992).

All XPress products (below) provide guaranteed electrical continuity once the joints are pressed.

After all plumbing work has been completed, always ensure continuity checks are conducted by a qualified electrician in accordance with regulations.

ELECTRICAL CONTINUITY	
XPRESS COPPER	✓
XPRESS STAINLESS	✓
XPRESS CARBON	✓
XPRESS COPPER GAS	✓
XPRESS STAINLESS GAS	✓
XPRESS SOLAR	✓



XPress fitting	Tube/pipe used with	Min. temperature and pressure		Max. temperature and pressure	
XPRESS COPPER	Copper	-20°C	16bar	110°C	16bar
XPRESS COPPER CHROMIUM PLATED	Copper chromium plated copper	-20°C	16bar	110°C	16bar
XPRESS STAINLESS	Stainless steel	-35°C	16bar	135°C	16bar
XPRESS CARBON	Carbon steel	-35°C	16bar	135°C	16bar
	Plastic coated carbon steel	-35°C	16bar	135°C	16bar
XPRESS COPPER GAS	Copper	-20°C	1bar*	70°C	5bar**
XPRESS STAINLESS GAS	Stainless steel	-20°C	1bar*	70°C	5bar**
XPRESS SOLAR†	Copper	-20°C	3bar	200°C	10bar

All performance figures based on correct assembly of fittings and tube/pipe as detailed in installation instructions. \*1bar inside. \*\*5bar outside above ground. †For solar application refer to the Solar Exposure table on page 135.



## 3.0 TECHNICAL DATA

# TUBES, PIPE AND THEIR COMPATIBILITIES



### COPPER TUBE

Compatible copper tube must meet the requirements of BS EN 1057 R250 and R290 for copper and copper alloy – seamless round copper tubes for water (and gas) in sanitary and heating applications.

The higher the number, the harder the material. As a result, tube diameter, wall thickness, length and the material temper must all be specified for full product designation.

All XPress Copper, Copper Gas and XPress Solar fittings can be used with copper tube, although in humid conditions some staining of the tube may be witnessed (see page 128 Phenolic foam section for details on moisture-proof insulation).

XPress Solar requires Copper tube capable of operating to higher temperature ratings (200°C) for Solar Application.

**Copper tube BS EN 1057 Compatibility:** XPress Copper, XPress Copper Gas fittings and XPress Solar. All tube tempers (R250 and R290) are available in all the designated wall thicknesses

Outside diameter	0.7mm	0.9mm	1.0mm	1.2mm	1.5mm	2.0mm	2.5mm
12mm	–	–	R290	–	–	–	–
15mm	R250 R290	–	R250 R290	–	–	–	–
22mm	–	R250 R290	R250 R290	R250 R290	–	–	–
28mm	–	R250 R290	R250 R290	R250 R290	R290	–	–
35mm	–	–	–	R250 R290	R290	–	–
42mm	–	–	–	R250 R290	R290	–	–
54mm	–	–	–	R250 R290	–	R290	–
66.7mm	–	–	–	R250	–	–	–
76.1mm	–	–	–	–	R250 R290	R290	–
88.9mm	–	–	–	–	–	R290	–
108mm	–	–	–	–	R250 R290	–	R290

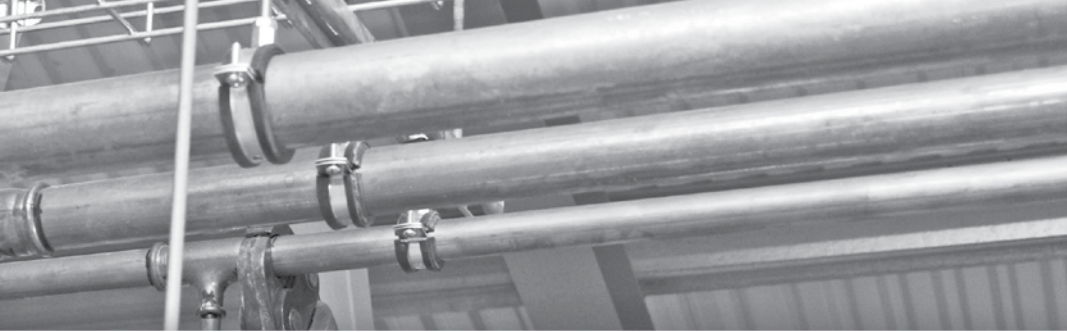

**STAINLESS STEEL 316 SYSTEM TUBE**

Specially designed to be used with XPress stainless steel fittings, 316 System tube is available in 6m straight lengths in sizes from 15 to 108mm. The tube is manufactured from BS 316 S31/DIN 1.4401 stainless steel strip conforming to BS10088 Part 2 and thanks to its thin-walled geometry, is stiff, lightweight and easy to handle.

However, when bending 316 System tube we recommend the use of the Rothenberger Robend 3000 with rollers up to 28mm - with the exception of SS610.

XPress stainless gas fittings are also compatible with stainless steel tubes to BS EN 10312 (encompassing the former BS 4127) and DVGW GW541.

Stainless steel 316 System tube: Specification			
Outside diameter	316 System tube SS610 (HWG) SS620 (HWG+S)	Wall thickness	
		EN 10312 Table 1 (formerly BS 4127) (Comparison)	EN 10312 Table 2 GW541 Table 3 (Comparison)
15mm	0.6mm	0.6mm	1.0mm
18mm	0.7mm	0.7mm	1.0mm
22mm	0.7mm	0.7mm	1.2mm
28mm	0.8mm	0.8mm	1.2mm
35mm	1.0mm	1.0mm	1.5mm
42mm	1.1mm	1.1mm	1.5mm
54mm	1.2mm	1.2mm	1.5mm
76.1mm	2.0mm	-	2.0mm
88.9mm	2.0mm	-	2.0mm
108mm	2.0mm	-	2.0mm



## 3.0 TECHNICAL DATA

# TUBES, PIPE AND THEIR COMPATIBILITIES



### **XPRESS GALVANISED CARBON STEEL SYSTEM TUBE AND PLASTIC COATED CARBON STEEL SYSTEM TUBE**

Carbon steel System tube is available in 3m straight lengths in sizes from 15 to 54mm, also available in 6m straight lengths in sizes from 15 to 108mm.

Plastic coated galvanised carbon steel tube is available in straight 6 metre lengths in sizes 15 to 54mm. Galvanised carbon steel System tube is manufactured in accordance with EN10305-3 from material with a very low carbon content and has a thin walled profile resulting in a lightweight easier to handle product.

The galvanised coating (external only) has a minimum thickness of 7 microns and is thermally applied which provides a superior bond to the tube and further resistance to corrosion.

XPress Carbon fittings can be used with our SC640 galvanised carbon steel System tube or our SC660 plastic coated carbon steel System tube.

Carbon tube and fittings should not be installed and exposed to the elements.

Prior to installation, XPress tube and fittings should be stored and protected under a protective cover. For exposed pipework consider XPress stainless steel.

XPress galvanised carbon steel tube: Specification

Outside diameter	Outside diameter including plastic coating	Wall thickness EN 10305-3 Table 1 GW541 Table 2 (formerly BS 4127)	
		Galvanised tube	Including plastic coating
15mm	17mm	1.2mm	2.2mm
18mm	19mm	1.2mm	2.2mm
22mm	24mm	1.5mm	2.5mm
28mm	30mm	1.5mm	2.5mm
35mm	37mm	1.5mm	2.5mm
42mm	44mm	1.5mm	2.5mm
54mm	56mm	1.5mm	2.5mm
66.7mm	–	1.5mm	–
76.1mm	–	2.0mm	–
88.9mm	–	2.0mm	–
108mm	–	2.0mm	–



### 3.0 TECHNICAL DATA

## XPRESS TUBE SPECIFICATIONS

CONNECT + CONTROL

#### SS600 Stainless Steel 316 Tube (HWG+S) 1.4401

Suitable for Heating, Potable Water, Gas and XPress Sprinkler Systems

LPCB  
Approved

Outer Size	Tube Length metre	Inner $\phi$	Wall thickness	Specifications/ Table	Mass Kg/m	Tube Capacity L/m	Code
15mm	6	13.0	1.0	EN 10312 Table2	0.350	0.133	25050
18mm		16.0	1.0		0.425	0.201	25051
22mm		19.6	1.2		0.624	0.302	25052
28mm		25.6	1.2		0.804	0.515	25053
35mm		32.0	1.5		1.257	0.804	25054
42mm		39.0	1.5		1.519	1.195	25055
54mm		51.0	1.5		1.969	2.043	25056

#### SS610 Stainless Steel 316 Tube (HWG) 1.4401

Suitable for Heating, Potable Water, Gas. Not suitable for XPress Sprinkler Systems

Outer Size	Tube Length metre	Inner $\phi$	Wall thickness	Specifications/ Table	Mass Kg/m	Tube Capacity L/m	Code
15mm	6	13.8	0.6	EN 10312 Table1	0.216	0.150	25010
18mm		16.6	0.7		0.303	0.216	25001
22mm		20.6	0.7		0.373	0.333	25002
28mm		26.4	0.8		0.544	0.547	25016
35mm		33.0	1.0		0.850	0.855	25018
42mm		39.8	1.1		1.125	1.244	25019
54mm		51.6	1.2		1.584	2.091	25021

#### SS620 Stainless Steel 316 Tube (HWG+S) 1.4401

Suitable for Heating, Potable Water, Gas and XPress Sprinkler Systems

LPCB  
Approved

Outer Size	Tube Length metre	Inner $\phi$	Wall thickness	Specifications/ Table	Mass Kg/m	Tube Capacity L/m	Code
76.1mm	6	72.0	2.0	EN 10312 Table 2	3.701	4.072	25026
88.9mm		84.9	2.0		4.346	5.661	25028
108mm		104.0	2.0		5.302	8.495	25030

#### SS630 Stainless Steel AISI 444 Grade Sprinkler Tube 1.4521

Suitable for Heating and XPress Sprinkler Systems

LPCB  
Approved

Outer Size	Tube Length metre	Inner $\phi$	Wall thickness	Specifications/ Table	Mass Kg/m	Tube Capacity L/m	Code
22mm	6	19.6	1.2	EN 10312	0.624	0.302	25072
28mm		25.6	1.2		0.804	0.515	25073
35mm		32.0	1.5		1.240	0.804	25074
42mm		39.0	1.5		1.519	1.195	25075
54mm		51.0	1.5		1.969	2.043	25076

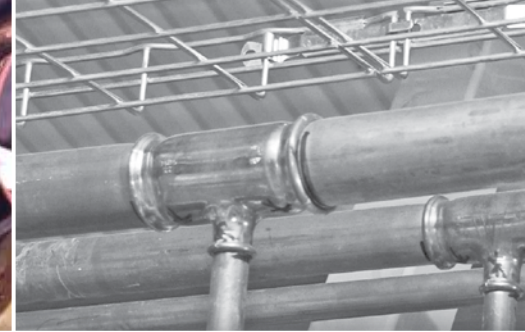

## 3.0 TECHNICAL DATA

### XPRESS TUBE SPECIFICATIONS

#### SS640 Stainless Steel AISI 439 Grade Sprinkler Tube 1.4520

Suitable for Heating and XPress Sprinkler Systems

LPCB  
Approved

Outer Size	Tube Length metre	Inner ø	Wall thickness	Specifications/ Table	Mass Kg/m	Tube Capacity L/m	Code
22mm	6	19.6	1.2	EN 10296-2	0.624	0.302	25067
28mm		25.6	1.2		0.804	0.515	25068
35mm		32.0	1.5		1.257	0.804	25069
42mm		39.0	1.5		1.519	1.195	25070
54mm		51.0	1.5		1.969	2.043	25071

#### SC640 Tectite / XPress Standard Carbon Galvanised Tube

Suitable for Heating/Chilled applications. Not suitable for XPress Carbon Sprinkler System

NEW  
3m

Outer Size	Tube Length metre	Inner ø	Wall thickness	Specifications/ Table	Mass Kg/m	Tube Capacity L/m	Code
15mm	3	12.6	1.2	EN 10305-3 (previously DIN 2394)	0.408	0.125	45080
18mm		15.6	1.2		0.497	0.191	45081
22mm		19.0	1.5		0.758	0.284	45082
28mm		25.0	1.5		0.980	0.491	45083
35mm		32.0	1.5		1.239	0.804	45084
42mm		39.0	1.5		1.498	1.195	45085
54mm		51.0	1.5		1.942	2.043	45086

#### SC640 Tectite / XPress Standard Carbon Galvanised Tube

Suitable for Heating/Chilled applications. Not suitable for XPress Carbon Sprinkler System

6m

Outer Size	Tube Length metre	Inner ø	Wall thickness	Specifications/ Table	Mass Kg/m	Tube Capacity L/m	Code
15mm	6	12.6	1.2	EN 10305-3 (previously DIN 2394)	0.408	0.125	25080
18mm		15.6	1.2		0.497	0.191	25081
22mm		19.0	1.5		0.758	0.284	25082
28mm		25.0	1.5		0.980	0.491	25083
35mm		32.0	1.5		1.239	0.804	25084
42mm		39.0	1.5		1.498	1.195	25085
54mm		51.0	1.5		1.942	2.043	25086
66.7mm		63.7	1.5		2.412	3.187	25090
76.1mm		72.0	2.0		3.650	4.072	25087
88.9mm		84.9	2.0		4.286	5.661	25088
108mm		104.0	2.0		5.228	8.495	25089



### SC645 XPress Sprinkler Carbon Galvanised Tube

Suitable XPress Carbon Sprinkler System only

LPCB Approved

Outer Size	Tube Length metre	Inner ø	Wall thickness	Specifications/ Table	Mass Kg/m	Tube Capacity L/m	Code
22mm	3	19.0	1.5	EN 10305-3 (previously DIN 2394)	0.758	0.284	25102
28mm		25.0	1.5		0.980	0.491	25103
35mm		32.0	1.5		1.239	0.804	25104
42mm		39.0	1.5		1.498	1.195	25105
54mm		51.0	1.5		1.942	2.043	25106

### SC645 XPress Sprinkler Carbon Galvanised Tube

Suitable XPress Carbon Sprinkler System only

LPCB Approved

Outer Size	Tube Length metre	Inner ø	Wall thickness	Specifications/ Table	Mass Kg/m	Tube Capacity L/m	Code
22mm	6	19.0	1.5	EN 10305-3 (previously DIN 2394)	0.758	0.284	25094
28mm		25.0	1.5		0.980	0.491	25095
35mm		32.0	1.5		1.239	0.804	25096
42mm		39.0	1.5		1.498	1.195	25097
54mm		51.0	1.5		1.942	2.043	25098
76.1mm*		72.0	2.0		3.650	4.072	25099
88.9mm*		84.9	2.0		4.286	5.661	25100
108mm*		104.0	2.0		5.228	8.495	25101

\* Not LPCB Approved

### SC660 XPress Standard Carbon Tube with Plastic Coating

Suitable for Heating/Chilled applications. Not suitable for XPress Carbon Sprinkler System

Outer Size	Tube Length metre	Inner ø	Wall thickness	Specifications/ Table	Mass Kg/m	Tube Capacity L/m	Code
15mm	6	12.6	1.2	EN 10305-3 (previously DIN 2394)	0.408	0.125	25060
18mm		15.6	1.2		0.497	0.191	25061
22mm		19.0	1.5		0.758	0.284	25062
28mm		25.0	1.5		0.980	0.491	25063
35mm		32.0	1.5		1.239	0.804	25064
42mm		39.0	1.5		1.498	1.195	25065
54mm		51.0	1.5		1.942	2.043	25066



## 3.0 TECHNICAL DATA

# XPRESS TUBE SPECIFICATIONS

### XPRESS STAINLESS STEEL TUBE (SS610) 1.4401

The XPress /Tectite Stainless Steel Tube is available in sizes from 15 to 54mm and is ideal for potable and heating installations. When used in an XPress System, it is suitable for use with gas applications. As part of the BSI (formerly GL/British Gas) approvals process, XPress Stainless Gas System (tube and fittings) has passed the High Temperature Leakage Rate test at 650°C for 30minutes at PN5/GT1.

Lightweight and easy to handle XPress/ Tectite Stainless Steel Tube allows for ease of installation when used in straight lengths. We do not recommend tube bending for SS610, see table opposite.

### APPLICATIONS

- ✚ Installations always have to comply with local regulations
- ✚ Suitable for a wide range of applications including (H.W) Heating and Water
- ✚ All potable water installations in accordance with international drinking water institutes, for example WRAS
- ✚ Potable water industrial applications e.g. Pharmaceutical, food and healthcare environments
- ✚ Water supply and rainwater installations
- ✚ Chilled water and heating applications
- ✚ Conditioned water such as decalcified/ softened water, partial and complete desalinated water, distilled water with glycol\* (concentrations of up to 40%)
- ✚ Compressed air systems (see page 133)

\*Further additives for antifreeze must be compatible with EPDM O Rings. Approval must be sought from Pegler Yorkshire prior to installation.

### TECHNICAL CHARACTERISTICS

TECHNICAL CHARACTERISTICS	
Manufacturing specification	EN 10312 – Table1
Material	Stainless Steel Tube X5CrNiMo 17 12 2 material No. 1.4401 BS 316 S31/DIN 1,4401 Strips conforming to BS EN 1008-2; 2005
Manufacturing process	BS 316 S31/DIN 1,4401 Strips conforming to BS EN 1008-2; 2005 TIG weld 100% EDDY CURRENT tested according to BS EN 10246-2
Finish	As welded
Marking	Tectite/XPress Stainless System Tube SS610 [dimensions x wall thickness] mm 16 bar -20°C to 110°C [date/time] [batch number] [stock control code]
Surface finish	Matt silver coloured
Smallest bending radius	Bending is not recommended
Supply mode	Tubes are supplied in 6m lengths -0/+50mm with protective caps (Green)
Heat expansion	0.0160mm/m at $\Delta T = 1K$
Max. operating pressure	16bar

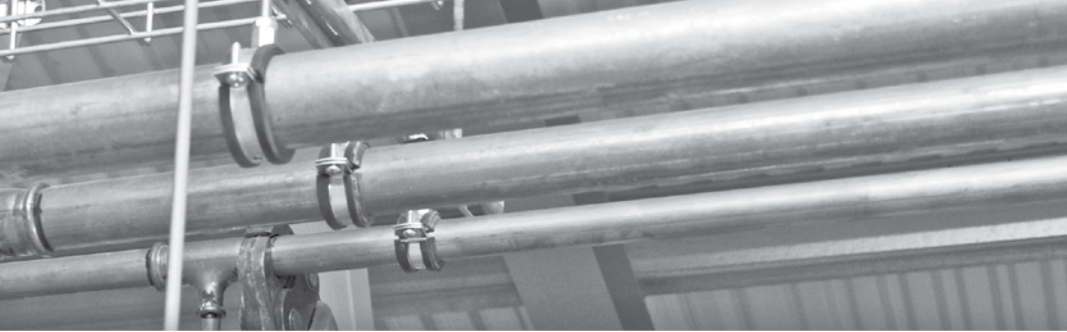

**XPRESS STAINLESS STEEL TUBE  
(SS600/SS620) 1.4401 (AISI 316)**

The XPress stainless steel tube has been tested and approved for potable water installations by many international certification institutes including WRAS, LPCB, to DVGW/DIN and DVGW-Worksheet GW541.

As part of the DVGW/BSI (formerly GL,British Gas) approvals process, XPress Stainless Steel Gas fittings have passed the High Temperature Leakage Rate Test at 650°C for 30 minutes at PN5/GT1. The maximum working pressure inside buildings is 1bar and outside buildings is 5bar (maximum pressure test 7.5bar)

**APPLICATIONS**

- + Installations always have to comply with local regulations
- + Suitable for a wide range of applications including (H.W.G.S) Heating, Water, Gas & Stainless Sprinkler System
- + All potable water installations in accordance with international drinking water institutes, for example, WRAS the German Potable Water Decree (TrinkwV) and EU council directive 98/83/EC, DIN50930 Part 6 and in compliance with DIN 1988
- + Water supply and rain water installations
- + Potable water for industrial applications
- + Wet and dry fire mains in accordance with DIN 1988 Part 6, VdS, FG, CNBOP, SBSC, FM, LPCB and UL/CUL
- + Conditioned water such as decalcified/softened water, partly and completely desalinated water, distilled water, water with glycol.\*
- + Compressed air (see page 133)

TECHNICAL CHARACTERISTICS	
Material	Stainless steel tube X5CrNiMo 17 12 2 Material no. 1.4401 according to DIN-EN 10088-2
Approvals	DVGW, SVGW, ETA, ÖVGW, BYGGFORSK, STF, PZH, SITAC, CSTBat, WRAS, VdS, FM, FG, CNBOP, SBSC, SETSCO, LPCB, DNV, GL, LR, UL, cUL
Tolerances	According to EN 10312 Table 2
Finishing	Annealed under a protective atmosphere W2R
Surface finish	Matt silver coloured
Marking	SudoXPress Stainless DN[ ]/[size x wall thickness]mm, Stainless steel/Edelstahl-Sanitary/Sanitar –GAS, 1.4001/AISI316, EN10312, DVGW GW541 Reg. Nr. DW-7301BM5610, SVGW, ÖVGW W1.397 WRAS, ETA, BYGGFORSK, STF, PZH, SITAC 0168/04, CSTBat 116-1482, LPCB, VdS G4080007 [working pressure VdS] bar, <FM> [working pressure FM] psi, C(UL)US Listed 4NB1 [working pressure UL] psi, DNV, GL, NDE, [batch number or production date], [supplier code] [max.every 60cm the model designation repeated]
Smallest bending radius	15mm to 28mm - 3.5 x external diameter of the tube. 35mm & above - bending is not recommended
Supply mode	Tubes, length of 6m +0/-50mm, with protective caps (Green)
Heat expansion coefficient	0.0160mm/m with ΔT=1K
Max. operating pressure	16bar

- + Conditioned installations for burnable gases: natural gases and liquid gases according to DVGW Worksheet G260 I/II. Installations of gas and liquid gas conducting tube installations according to DVGW – Worksheet G600, DVGW- TRGI 86/89 and TRF 1996.

\*Further additives for antifreeze must be compatible with EPDM O Rings. Approval must be sought from Pegler Yorkshire prior to installation.



## 3.0 TECHNICAL DATA

### XPRESS TUBE SPECIFICATIONS

#### XPRESS STAINLESS STEEL TUBE (SS630) 1.4521 (AISI 444)

XPress Nickel free stainless steel tube is ideal for heating applications and XPress Stainless Sprinkler System.

#### APPLICATIONS

- ✚ Wet and dry fire mains in accordance with DIN 1988 Part 6, or FM and LPCB
- ✚ Conditioned water such as decalcified/softened water, partly and completely desalinated water, distilled water, water with glycol\* (concentrations of up to 40%)
- ✚ Compressed air (see page 133)

\*Further additives for antifreeze must be compatible with EPDM O Rings. Approval must be sought from Pegler Yorkshire prior to installation.

#### TECHNICAL CHARACTERISTICS

Material	SudoXPress Stainless steel tube X2CrMoTi 18 2 Material no. 1.4521 according to DIN-EN 10088-2
Approvals	DVGW, SVGW, ETA, FM, ÖVGW, FG, LPCB, DNV, GL, LR, UL, cUL
Tolerances	According to EN 10312 Table 2
Finishing	Annealed under a protective atmosphere W2R
Surface finish	Matt silver coloured
Marking	SudoXPress Stainless DN[ ]/[size x wall thickness] mm, Edelstahl Stainless steel, 1.4521/AISI444 W2R, EN 10312, DVGW GW541 Reg. Nr. DW-7301BP5610, SVGW, ÖVGW, ETA, LPCB, <FM> [working pressure FM] psi, C(UL)US Listed 4NB1 [working pressure UL] psi, DNV, GL, NDE, Tectite 316 [batch number or production date], [supplier code] [max.every 60cm the model designation repeated]
Smallest bending radius	3.5 x external diameter of the tube (max.28mm)
Supply mode	Tubes, length of 6m +/-50mm, with protective caps (Green)
Heat expansion coefficient	0.0104mm/m withΔT=1K
Max. operating pressure	16 bar

#### XPRESS STAINLESS STEEL TUBE (SS640) 1.4520 (AISI 439)

The 1.4520 stainless steel tube is AISI 439 stainless steel tube with no Nickel content, making it a cost effective alternative. The tube has been tested and approved by FM for use in dry and wet fixed XPress Stainless Sprinkler Systems.

#### APPLICATIONS

- ✚ Wet and dry fire mains in accordance with FM and LPCB
- ✚ Compressed air (see page 133)
- ✚ Solar installations
- ✚ Cooling installations
- ✚ Heating installations

#### TECHNICAL CHARACTERISTICS

Material	SudoXPress Stainless steel tube X2CrTi17 Material no. 1.4520 according to DIN-EN 10088-2
Approvals	FM, FG, LPCB, UL, cUL
Tolerances	According to EN 10296-2
Finishing	Annealed under a protective atmosphere W2R
Surface finish	Matt silver coloured
Marking	Stainless DN[ ]/[size x wall thickness]mm , Stainless steel /Edelstahl 1.4520/AISI439, Heating/Compressed air-Heizung/Druckluft, LPCB, <FM> [working pressure FM] psi, C(UL)US Listed 4NB1 [working pressure UL] psi, NDE, [batch number or production date], [supplier code] [max.every 60cm the model designation repeated]
Smallest bending radius	3.5 x external diameter of the tube (max.28mm)
Supply mode	Tubes, length of 6m +/-50mm, with protective caps (Black)
Heat expansion coefficient	0.0104mm/m withΔT=1K
Max. operating pressure	16bar



### XPRESS CARBON STEEL TUBE (SC640)

XPress Carbon tubes are thin-walled precision tubes manufactured in accordance with EN 10305-3 (previously DIN 2394/NEN 1982) from a special kind of steel that has a very low carbon content. The resulting product is very easy to bend. The absence of leaks is also checked, in accordance with EN 10246-1, so that all tubes will be guaranteed leak free.

#### APPLICATIONS

- ✚ Closed loop heating installations according to DIN 4751
- ✚ Closed loop cooling installations with water/glycol mixture\* concentrations of up to 40%
- ✚ Compressed air, dry or oil containing
- ✚ Solar applications (closed loop)
- ✚ Shipbuilding

\*Further additives for antifreeze must be compatible with EPDM O Rings. Approval must be sought from Pegler Yorkshire prior to installation.

TECHNICAL CHARACTERISTICS	
Material	XPress Carbon Steel tube Unalloyed ULC (Ultra Light Carbon) Carbon steel, Rst 34-2 Mat. No. 1.0034 according to EN 10305-3
Approvals	CSTBat, DNV, GL, RINA
Tolerances	According to EN 10305-3
Finishing	Zinc coating of at least 8-15µm. The tube welding seam is subsequently galvanized on the outside. Inside of the tube is protected by a thermally applied oil film.
Surface finish	Silver coloured
Marking	Carbon Steel Tube Marking SC640 - SudoXPress galvanised DN [ ]/[size x wall thickness]mm, EN10305-3 CSTBat 116-1483,[batch number or production date],[supplier code],[model designation] SC660 – SudoXPress galvanised DN [ ]/[size x wall thickness]mm, polypropylene coated, EN10305-3 CSTBat 116-1483,[batch number or production date],[supplier code],[model designation]
Smallest bending radius	3.5 x external diameter of the tube (max. 28mm)
Supply mode	Tubes, length 6m +0/-50mm, with protective caps (Red)
Heat expansion coefficient	0.0108mm/m at ΔT = 1K
Max. operating pressure	16bar



## 3.0 TECHNICAL DATA

### XPRESS TUBE SPECIFICATIONS

#### XPRESS CARBON STEEL TUBE - PLASTIC COATED (SC660)

XPress Carbon tubes with polypropylene coating are used for the same applications and have the same technical characteristics as XPress Carbon tubes (polypropylene coated tubes are marked "Galvanized Polypropylene coated") and are coated with a layer of polypropylene (PP) for protection against outer corrosion. The PP has a smooth surface and good resistance to tearing and impact. For a safe press fitting connection, it is essential to remove the polypropylene coating with a jacket stripping unit along the insertion depth. The rigidity of the press connection is only achieved by maintaining the insertion depth.

TECHNICAL CHARACTERISTICS	
Material	XPress Carbon steel tube unalloyed ULC (Ultra Light Carbon) Carbon steel, Rst 34-2 part No. 1.0034 according to EN 10305-3
Approvals	CSTBat, DNV, GL, RINA
Tolerances	According to EN 10305-3
Finishing	Zinc coating of at least 8-15µm. The tube welding seam is subsequently galvanized on the outside. Inside of the tube is protected by a thermally applied oil film
Surface finish	High-heat stabilized polypropylene PP (B2) thickness ±1 mm, RAL 9001
Marking	SudoXPress DN (dimension x wall thickness mm) galvanized – Polypropylene coated EN10305-3 logo CSTBat 116-1483 DNV, GL, [batch numbers] [Supplier number]
Smallest bending radius	3.5 x external diameter of the tube (max.28mm)
Supply mode	Tubes, length of 6m +0/-50mm, with protective caps (Red)
Heat expansion coefficient	0.0108mm/m withΔT=1K
Max. operating pressure	16bar
Thermal load	120°C permanent load
Heat conductivity	0.22 W/mK

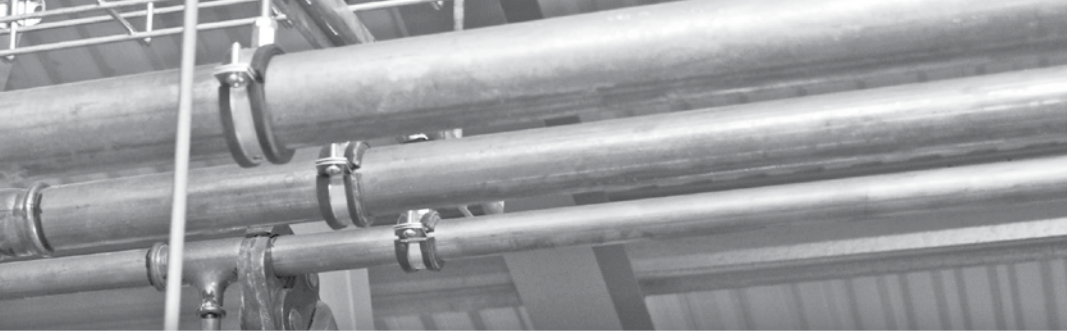

### XPRESS SPRINKLER GALVANISED STEEL TUBES (SC645)

The XPress Sprinkler Galvanized tubes for wet sprinkler systems only. Thin-walled precision steel tubes, they are made from cold rolled steel that is galvanized using the Sendzimir process. During this process zinc is brought onto the metal strip, running through a zinc bath, covering both sides simultaneously. The tube is protected both on the inside and outside with a zinc layer, with a thickness of 15 to 27µm. After welding, the seam is additionally zinc plated. With the Sendzimir process a good adhesion of the zinc layer and corrosion resistance is achieved.

#### APPLICATIONS

- Wet fixed sprinkler installations in accordance with DIN 1988 Part 6, VdS, FM, FG, SBSC and CNBOP

TECHNICAL CHARACTERISTICS	
Material	XPress Carbon Sprinkler tube unalloyed ULC (ultra light carbon) Carbon steel, E190 part No. 1.0031 according to EN 10305-3
Approvals	VdS, FM, FG, CNBOP, SBSC, SETSCO, UL, cUL
Tolerances	According to EN 10305-3
Finishing	Zinc coating of at least 20µm according steel grade ZNT275. The tube welding seam is subsequently galvanized on the outside.
Surface finish	Silver coloured
Marking	XPress galvanised, DN[ ]/[size x wall thickness mm], LPCB, VdS G4080007 [working pressure VdS] bar, <FM> [working pressure FM] psi, C(UL)US Listed 4NB1 [working pressure UL] psi, CRR UL [CRR UL] CRR cUL [CRR uL], DNV, GL, NDE, [batch number or production date], [supplier code] [max. every 60cm the model designation repeated]
Smallest bending radius	3.5 x external diameter of the tube (max. 28mm)
Supply mode	Tubes, length of 3 and 6m +0/-50mm, with protective caps (Lilac)
Heat expansion coefficient	0.0108mm/m with ΔT=1K
Max. operating pressure	16bar



## 3.0 TECHNICAL DATA

# XPRESS TUBE MANUFACTURING SPECIFICATIONS

MANUFACTURING SPECIFICATIONS				
Product	Specification	Type of tubing	Welding deterioration reduction	Weld slag removal
SS600 (AISI 316) Stainless steel	EN 10312-DVGW worksheet GW541(2004) Table 2	TIG or laser welded	100% EDDY CURRENT tested according to SEP 1914/EN 10246-2	Outside
SS610 (AISI 316) Stainless steel	EN 10312 Table 1	TIG welded	100% EDDY CURRENT tested according to BS EN 10246-2	N/A
SS620 (AISI 316) Stainless steel	EN 10312-DVGW worksheet GW541(2004) Table 2	TIG or laser welded	100% EDDY CURRENT tested according to SEP 1914/EN 10246-2	Outside
SS630 (AISI 444) Stainless steel	EN 10312-DVGW worksheet GW541(2004) Table 2	Laser welded	100% EDDY CURRENT tested according to SEP 1914/EN 10246-2	Outside
SS640 (AISI 439) Stainless steel	EN 10296-2	Laser welded	100% EDDY CURRENT tested according to SEP 1914/EN 10246-2	Outside
SC640 Carbon steel	EN 10305-3	HF welded	100% EDDY CURRENT tested according to SEP 1914/EN 10246-2	Outside flat, inside raise max.0.5mm
SC645 Carbon steel	EN 10305-3	HF welded	100% EDDY CURRENT tested according to SEP-1925	Outside weld flat insight raising max.0.5mm for dimensions >54mm 0.8mm
SC660 Stainless steel	EN 10305-3 (previously DIN 2394)	Laser welded	100% EDDY CURRENT or tested according to SEP 1914/EN 10246-2	Outside

### TRANSPORT AND STORAGE

We recommend that tube is not left exposed to the elements, and that end caps remain in place during storage.

During transport and storage of XPress Sprinkler tubes and press fittings it is important to avoid damage and soiling. The best storage temperature for fittings and tubes is between 10°C and 25°C and they should be stored in a dry area (maximum humidity 65%). The storage of tubes should be horizontal, separated by

wooden blocks. Bundles should not be stacked higher than the recommended maximum height in order to prevent tubes from becoming oval (the maximum height should not exceed 6 bundles, when stacking stack in 2x2/3x3, etc.). Please ensure that carbon and stainless tubes are stored separately.

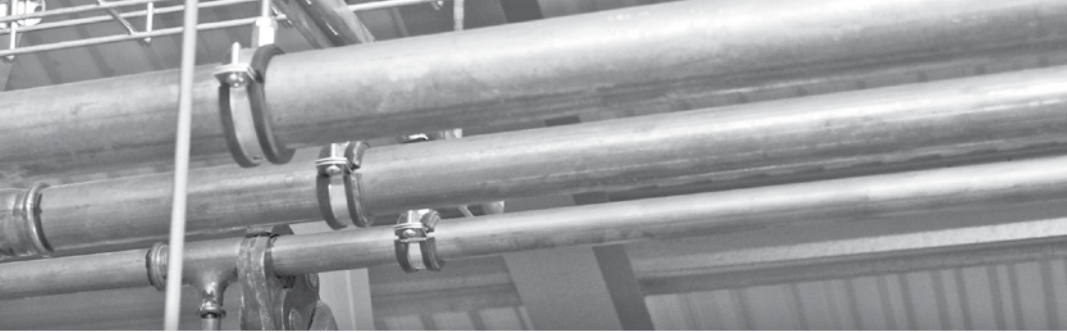

### 3.0 TECHNICAL DATA

## SYSTEM DESIGN CONSIDERATIONS AND TUBE EXPANSION

CONNECT + CONTROL

The following are some of the specific design considerations which are important to take account of when designing and installing pipework systems containing XPress fittings.

#### THERMAL MOVEMENT

Thermal movement is a major consideration when designing plumbing and heating systems. Pipework systems expand and contract with changes in temperature. If they are fixed too rigidly and their movement restricted, the systems will be subject to stress

which must be avoided. So it's important to take the effect of thermal movement into account when designing or installing a system.

It's especially important to avoid stress concentrations between fixed points typically found at radiators, valves and other fittings.

The following tables show thermal expansion details for a range of tube/pipe lengths and temperature changes.

XPRESS COPPER, XPRESS COPPER GAS AND XPRESS SOLAR: COPPER TUBE EXPANSION										
Temperature change	Tube Length									
	3m	4m	5m	6m	7m	8m	9m	10m	12m	25m
10°C	0.5mm	0.7mm	0.9mm	1.0mm	1.2mm	1.4mm	1.5mm	1.7mm	2.0mm	4.3mm
20°C	1.0mm	1.4mm	1.7mm	2.0mm	2.4mm	2.7mm	3.0mm	3.4mm	4.0mm	8.5mm
30°C	1.5mm	2.0mm	2.6mm	3.1mm	3.6mm	4.1mm	4.6mm	5.1mm	6.1mm	13.0mm
40°C	2.0mm	2.7mm	3.4mm	4.1mm	4.8mm	5.4mm	6.1mm	6.8mm	8.2mm	17.0mm
50°C	2.6mm	3.4mm	4.3mm	5.1mm	6.0mm	6.8mm	7.7mm	8.5mm	10.2mm	21.0mm
60°C	3.1mm	4.1mm	5.1mm	6.1mm	7.1mm	8.2mm	9.2mm	10.2mm	12.2mm	26.0mm
70°C	3.6mm	4.8mm	6.0mm	7.1mm	8.3mm	9.5mm	10.7mm	11.9mm	14.3mm	30.0mm
80°C	4.1mm	5.4mm	6.8mm	8.2mm	9.5mm	10.9mm	12.2mm	13.6mm	16.3mm	34.0mm
90°C	4.6mm	6.1mm	7.7mm	9.2mm	10.7mm	12.2mm	13.8mm	15.3mm	18.4mm	38.0mm
100°C	5.1mm	6.8mm	8.5mm	10.2mm	11.9mm	13.6mm	15.3mm	17.0mm	20.4mm	43.0mm
150°C	7.7mm	10.2mm	12.8mm	15.3mm	17.9mm	20.4mm	23.0mm	25.5mm	30.6mm	63.8mm
200°C	10.2mm	13.6mm	17.0mm	20.4mm	23.8mm	27.2mm	30.6mm	34.0mm	40.8mm	85.0mm

XPRESS STAINLESS AND XPRESS STAINLESS GAS: STAINLESS STEEL SYSTEM TUBE EXPANSION										
Temperature change	Tube Length									
	3m	4m	5m	6m	7m	8m	9m	10m	12m	25m
10°C	0.5mm	0.6mm	0.8mm	1.0mm	1.1mm	1.3mm	1.4mm	1.6mm	1.9mm	4.0mm
20°C	1.0mm	1.3mm	1.6mm	1.9mm	2.2mm	2.6mm	2.9mm	3.2mm	3.8mm	8.0mm
30°C	1.4mm	1.9mm	2.4mm	2.9mm	3.4mm	3.8mm	4.3mm	4.8mm	5.8mm	12.0mm
40°C	1.9mm	2.6mm	3.2mm	3.8mm	4.5mm	5.1mm	5.8mm	6.4mm	7.7mm	16.0mm
50°C	2.4mm	3.2mm	4.0mm	4.8mm	5.6mm	6.4mm	7.2mm	8.0mm	9.6mm	20.0mm
60°C	2.9mm	3.8mm	4.8mm	5.8mm	6.7mm	7.7mm	8.6mm	9.6mm	11.5mm	24.0mm
70°C	3.4mm	4.5mm	5.6mm	6.7mm	7.8mm	9.0mm	10.1mm	11.2mm	13.4mm	28.0mm
80°C	3.8mm	5.1mm	6.4mm	7.7mm	9.0mm	10.2mm	11.5mm	12.8mm	15.4mm	32.0mm
90°C	4.3mm	5.8mm	7.2mm	8.6mm	10.1mm	11.5mm	13.0mm	14.4mm	17.3mm	36.0mm
100°C	4.8mm	6.4mm	8.0mm	9.6mm	11.2mm	12.8mm	14.4mm	16.0mm	19.2mm	40.0mm

XPRESS CARBON**: GALVANISED CARBON STEEL SYSTEM TUBE AND PLASTIC COATED CARBON STEEL SYSTEM TUBE EXPANSION										
Temperature change	Tube Length									
	3m	4m	5m	6m	7m	8m	9m	10m	12m	25m
10°C	0.3mm	0.4mm	0.5mm	0.7mm	0.8mm	0.9mm	1.0mm	1.1mm	1.3mm	2.7mm
20°C	0.7mm	0.9mm	1.1mm	1.3mm	1.5mm	1.7mm	1.9mm	2.2mm	2.6mm	5.4mm
30°C	1.0mm	1.3mm	1.6mm	1.9mm	2.3mm	2.6mm	2.9mm	3.2mm	3.9mm	8.1mm
40°C	1.3mm	1.7mm	2.2mm	2.6mm	3.0mm	3.5mm	3.9mm	4.3mm	5.2mm	10.5mm
50°C	1.6mm	2.2mm	2.7mm	3.2mm	3.8mm	4.3mm	4.9mm	5.4mm	6.5mm	13.8mm
60°C	1.9mm	2.6mm	3.2mm	3.9mm	4.5mm	5.2mm	5.8mm	6.5mm	7.8mm	16.2mm
70°C	2.3mm	3.0mm	3.8mm	4.5mm	5.3mm	6.1mm	6.8mm	7.6mm	9.1mm	18.9mm
80°C	2.6mm	3.5mm	4.3mm	5.2mm	6.1mm	6.9mm	7.8mm	8.6mm	10.4mm	21.6mm
90°C	2.9mm	3.9mm	4.9mm	5.8mm	6.8mm	7.8mm	8.8mm	9.7mm	11.7mm	24.3mm
100°C	3.2mm	4.3mm	5.4mm	6.5mm	7.6mm	8.6mm	9.7mm	10.8mm	13.0mm	27.0mm

\*\* Closed circuit systems only.



## 3.0 TECHNICAL DATA

# SYSTEM DESIGN CONSIDERATIONS AND TUBE EXPANSION

### CALCULATION OF THE EXPANSION COMPENSATION LENGTH

In case of greater expansion, expansion compensators or, in complicated cases  $\Omega$ -shaped compensating loops will need to be fitted and calculated. The formula with which the expansion equaliser in mm is calculated is as follows:

$$B_d = k \times \sqrt{d_e \times \Delta l}$$

$B_d$  = expansion compensation length (mm)

$k$  = material constant

- 45 for XPress Stainless and Carbon tube,
- 35 for copper tubes

$d_e$  = outside diameter of the tube (mm)

$\Delta l$  = linear expansion that needs to be compensated (mm)

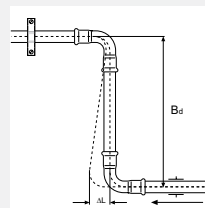

(Figure 12)

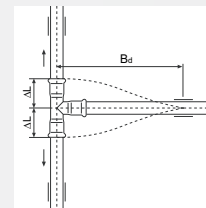

(Figure 13)

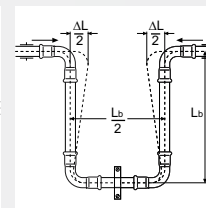

(Figure 14)

The nomogram in graph 1 enables the fast and accurate establishment of the expansion bend length ( $B_d$ ) considering the respective tube types and the expansion to be compensated ( $\Delta$ ). Graph 2 shows the values ( $L_b$ ) for the installation situation illustrated in figure 14.

The following is an example of an analytical calculation: A tube network with a length of 16m consisting of XPress Stainless tubing with a diameter of 22mm subject to a temperature difference of 60 K. When using the equation for calculating the expansion, the result is:

$$\Delta l = 16 \times 0.0166 \times 60 = 15.936$$

Without the requirement for the mathematical calculation, we would get the same result through interpolation of the data in table 20. With the expansion for the respective section of the pipeline, we need to calculate the length of the expansion compensator required for its compensation - see figures 12 and 13. Using the nomogram in graph 1, we get ca. 830mm. The analytical calculation shows:

$$B_d = 45 \times \sqrt{(22 \times 15.936)} = 827.2 \text{ mm}$$

In case of an  $\Omega$ -shaped expansion connection, the calculated value of the expansion equaliser also visible from figure 14 is to be halved as it is actually two expansion sections. The value ( $B_d$ ) is not exactly divided by two, but should be divided by a factor of 1.8:

$$L_b = 25 \times \sqrt{(22 \times 15.936)} = 468.1 \text{ mm}$$

or otherwise:

$$L_b = B_d / 1.8 = 842.58 / 1.8 = 468.1 \text{ mm}$$

**Graph 2 shows a value for  $L_b$  of ca. 468mm.**

As can be seen in figures 12-14, a correct compensation of the expansion depends also on the placement of fixing devices such as saddles and clips. Never plan for or place tube saddles as a mounting device close to a tube connection. Clips should be positioned such that they do not behave as a fixed restraint. When there are straight segments of tube, without expansion compensation, use only one saddle to prevent possible deformation. Position it as close to the middle of the straight segment as possible: in this way, any expansion will be distributed in both directions and the length of the expansion equaliser required will be halved. It is recommended that tube saddles with a rubber inlay are used as this muffles any possible noise and vibration and provides a better distribution of the stresses.

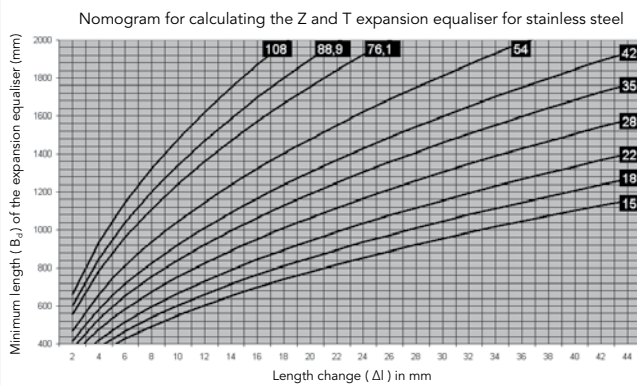

Graph 1: Nomogram (for XPress Stainless) for calculating the situation fig. 12 and 13. Expansion  $B_d$  (mm)

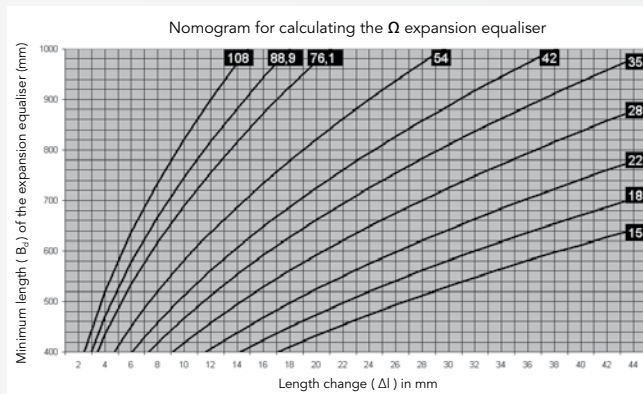

Graph 2: Nomogram for calculating the situation Fig. 14. Expansion compensator  $L_b$  (mm)



### HEAT LOSSES

Repetitive insulation for limiting heat losses is also required for the tubes in the XPress system, not just to save energy but also based on current norms and legal provisions (for example German law of 10/91, DIN 1988, part 2, EnEV). We refer to these regulations and their implementation regulations and the respective tables showing the minimum insulation thickness.

(Figures 17, 18, 19 and 20) show the linear heat losses of the tubes according to their diameter and temperature difference. The details in figures 17, 18 and 19 refer to bare tubes placed above screed. Figure 20 shows the heat loss for polypropylene coated tubes.

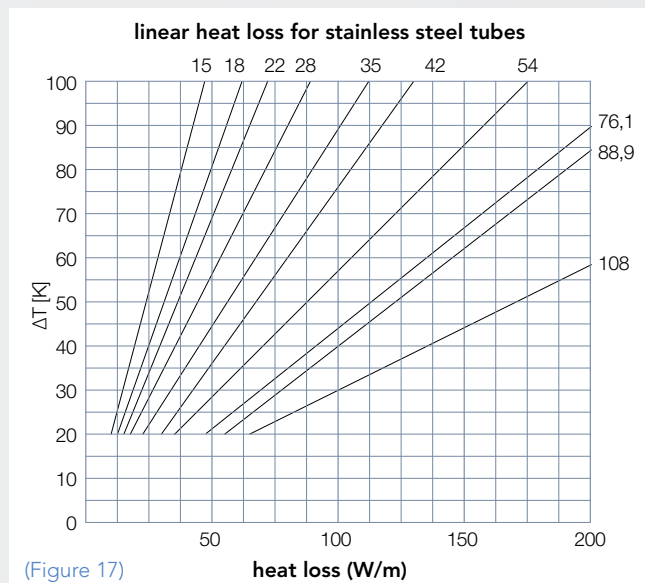

(Figure 17)

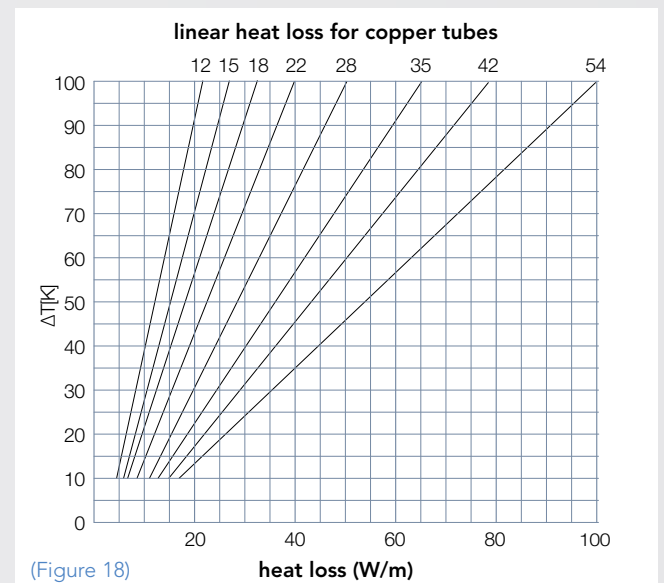

(Figure 18)

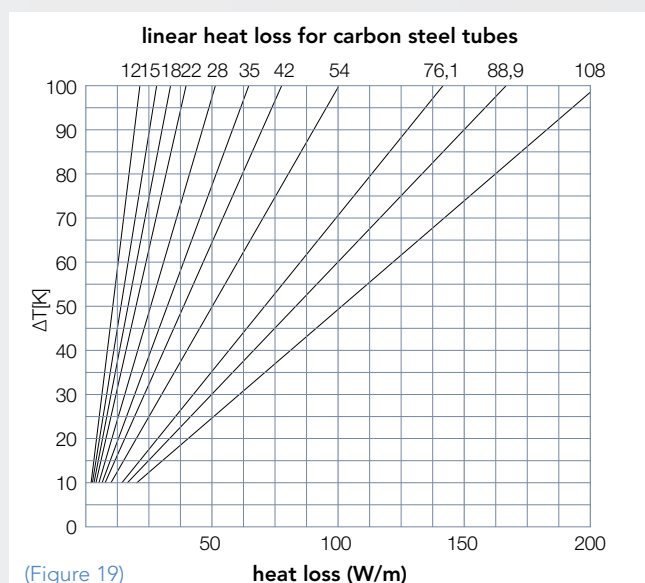

(Figure 19)

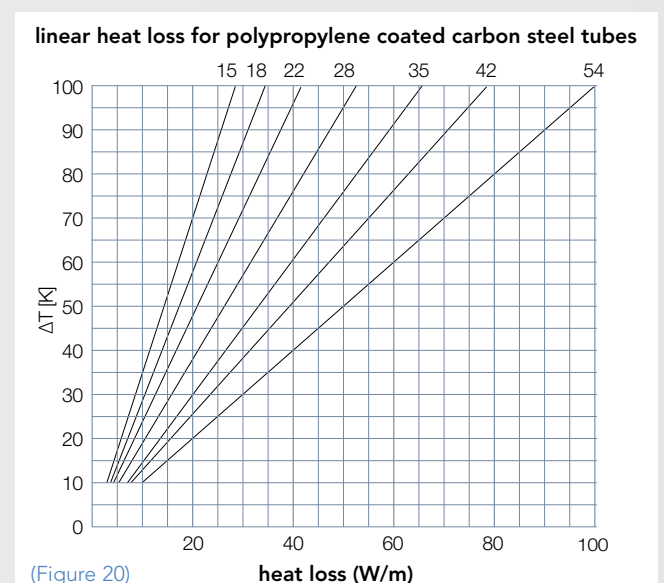

(Figure 20)



## 3.0 TECHNICAL DATA

# SYSTEM DESIGN CONSIDERATIONS AND TUBE EXPANSION

### EXPANSION AXIAL COMPENSATORS

The axial compensator is an expansion joint with a corrugated bellow in the centre and is supplied with press ends in sizes 15 to 54mm (SS75) or with male ends in sizes 76.1 to 108mm (SS76).

The axial compensator provides a solution for expansion and shrinking of your piping system whilst dampening vibrations and eliminating unwanted noise. Manufactured from stainless steel, they are suitable for a wide range of applications from ship building, chemical industry, and utility piping systems. The axial compensator provides flexibility where space is limited.



SS75 Expansion Axial Compensator



SS76 Expansion Axial Compensator Drum End

#### MATERIAL SPECIFICATION

Component	Connections	Materials
SS75 15-54mm	Press Ends	Stainless Steel 1.4404 (AISI 316L)
SS76 76.1-108mm	Male Ends	Stainless Steel 1.4401 (AISI 316)
Bellows		Stainless Steel 1.4571 (AISI 316 Ti) Multi-Ply
O Ring		Ethylene Propylene Diene Monomer

### INSULATION

For all XPress Systems, we recommend you adhere to the insulation requirements as specified by the Water Supply (Water Fittings) Regulations and Building Regulations 1999. These requirements are equally applicable to plastic pipe and stainless steel tube.

Pegler Yorkshire would always recommend that any insulation should be fitted in accordance with:

#### The Code of Practice BS5970:2012

- Thermal Insulation of Pipework, ductwork, associated equipment and other industrial installations in the temperature range of -100°C to +870° C.

Additional guidance can be found on an insulation manufacturer website.

We have the following specific recommendations for XPress systems:

Every effort should be made to ensure that the pipework and fittings are clean and dry prior to the fitment of insulation. To help to achieve this, the avoidance of water based media for leak detection should be considered.

Where Carbon Steel systems are used every effort should be made to protect the system from both internal and external corrosion. Both fittings and tubing should be stored undercover in a clean dry environment prior to installation.

Special consideration should be given to the effects of condensation on fittings and pipework. This may be caused by surrounding works during the construction cycle and not by the system itself.

The choice of insulation system should not be considered as the only means of preventing corrosion, the specifier must consider the whole process and the potential risk of corrosion taking place.

After initial installation, suitable vapour barriers need to be considered to ensure that NO WATER INGRESS is allowed to permeate the insulation.

Xpress Carbon and Tectite Carbon systems should not be installed in externally or exposed locations without due consideration to weathering protection. We would recommend that Stainless Steel or Xpress Copper be used for such applications.

### PHENOLIC FOAM

When using rigid phenolic foam (or other thermal insulation) to lag pipework, always remember to refer to the lagging manufacturer's fixing instructions. To avoid the risk of external corrosion of copper pipework lagged with this foam, the European Phenolic Foam Association recommend that such insulation products be installed with a moisture barrier. As a precautionary measure, Pegler Yorkshire does not recommend any anti-corrosion materials containing a mineral oil base are applied around the mouth of the fitting and this should instead be protected using silicon grease (or similar) to form the atmospheric barrier between the metal and the foam insulation.

An alternative would be to use an impervious material, such as PVC tape. This needs to be applied to the mouth of the fitting before applying any mineral oil-based materials. If a grease-free installation is preferred then butyl tape can be used to provide a vapour barrier.

Some manufacturers of this type of lagging supply their products with an internal, factory-applied silicate barrier to prevent external corrosion problems. However, if you do need to add a barrier product, we recommend that all XPress fittings be fully installed before these are applied and that they are completely coated.



Maximum spacing of support brackets for 316 System tube, BS 4127 and W541 stainless steel tube and plastic coated and galvanised carbon steel tube

Size	Horizontal pitch	Vertical pitch
15mm	1.80m	2.00m
18mm	2.10m	2.30m
22mm	2.40m	3.00m
28mm	2.40m	3.00m
35mm	2.70m	3.00m
42mm	3.00m	3.60m
54mm	3.00m	3.60m
76.1mm	3.00m	3.60m
88.9mm	3.60m	4.50m
108mm	3.60m	4.50m

Maximum spacing of support brackets for copper tube to BS EN 1057

Size	Wall thickness	Temper	Horizontal pitch	Vertical pitch
12mm	0.7mm	R250/R290	1.00m	1.50m
15mm	0.7mm	R250/R290	1.20m	1.80m
15mm	1.0mm	R250/R290	1.20m	1.80m
22mm	0.9mm	R250/R290	1.80m	2.40m
22mm	1.0mm	R250/R290	1.80m	2.40m
22mm	1.2mm	R250/R290	1.80m	2.40m
28mm	0.9mm	R250/R290	1.80m	2.40m
28mm	1.0mm	R250/R290	1.80m	2.40m
28mm	1.2mm	R250/R290	1.80m	2.40m
28mm	1.5mm	R250/R290	1.80m	2.40m
35mm	1.0mm	R250/R290	2.40m	3.00m
35mm	1.2mm	R250/R290	2.40m	3.00m
35mm	1.5mm	R250/R290	2.40m	3.00m
42mm	1.0mm	R250/R290	2.40m	3.00m
42mm	1.2mm	R250/R290	2.40m	3.00m
42mm	1.5mm	R250/R290	2.40m	3.00m
54mm	1.0mm	R250/R290	2.70m	3.00m
54mm	1.2mm	R250/R290	2.70m	3.00m
54mm	2.0mm	R250/R290	2.70m	3.00m
64mm	2.0mm	R250/R290	3.00m	3.60m
66.7mm	1.2mm	R250/R290	3.00m	3.60m

Maximum spacing of support brackets for copper tube to BS EN 1057

Size	Wall thickness	Temper	Horizontal pitch	Vertical pitch
66.7mm	1.2mm	R250/R290	3.00m	3.60m
66.7mm	2.0mm	R250/R290	3.00m	3.60m
76.1mm	1.5mm	R250/R290	3.00m	3.60m
76.1mm	2.0mm	R250/R290	3.00m	3.60m
88.9mm	2.0mm	R250/R290	3.00m	3.60m
108mm	1.5mm	R250/R290	3.00m	3.60m
108mm	2.5mm	R250/R290	3.00m	3.60m

### THERMAL EXPANSION

When including expansion joints in a system take care not to introduce tensional stress when assembling and tightening threaded connections. The XPress range includes male and female connectors for the correct jointing of expansion joints.

### CORRECT ANCHORING

Always ensure the spur used to anchor the branch of a tee or connecting a radiator is long enough to allow normal thermal movement. Forgetting to observe this simple rule can lead to a failure. Incorporating expansion loops or bellow devices into the system can help guard against such problems, whilst a horseshoe link or offset (see diagrams) is an ideal way to counteract continual thermal cycling.

### PIPE RESTRAINT

In any installation, the system should be supported to ensure the minimum stress is imposed on the tube/pipe and joints. For the maximum spacing of supporting brackets for internal installations, please see the tables (opposite).

### LOCAL WATER AUTHORITY

We recommend consulting the local water authority when it comes to pipework accessibility.

### BUILDING IN DIMENSIONS

All building in dimensions are correct at the time of going to press. Pegler Yorkshire reserves the right to change these dimensions without prior notice, however to ensure you are using the most up to date information please refer to our web site [www.pegleryorkshire.co.uk](http://www.pegleryorkshire.co.uk)

### COVERED PIPEWORK

Making provision for thermal movement is vital where pipework of any material is installed under screed or plaster or passes through brick or blockwork. The preferred practice is to use tubing with factory applied protective plastic covering incorporating air gaps to accommodate thermal movement or to pass tubes and pipes through sleeves or conduits or to lay them in ducts surrounded by loose, inert non-rigid material such as vermiculite or glass wool. For further information, consult the publication BS 66.700:2006 Design, installation, testing and maintenance of services supplying water for domestic use within buildings their curtilages.

### FLUSHING

The main objective of the flushing process is to remove as much dirt and debris from the pipework system as possible in order to reduce the likelihood of system blockage and to create the best possible circumstances for a successful chemical clean and subsequent water treatment regime so that any hygiene problems and corrosion damage within a system are largely prevented.

The level of cleanliness achievable by system flushing is very much dependant on the adequacy of the system design and installation with regard to flushing. Provision should be included in the system for adequate air venting, draining and bypassing of equipment.

Consideration should be given to the 'Flushing Velocity' and should be based on the largest pipe size in the system section to be flushed.



## 3.0 TECHNICAL DATA

# SYSTEM DESIGN CONSIDERATIONS AND TUBE EXPANSION

The water velocity required for flushing must be sufficient to pick up and carry the majority of the dirt and debris from within the system.

The hot and cold water pipelines should be flushed separately.

For details, please refer to the BSRIA Guide BG29-2012 'Pre-Commissioning Cleaning of Pipework Systems'.

Some contracts may still require that proprietary chemicals are used to cleanse and flush pipework before full commissioning. XPress is compatible with a wide selection of products. To find out more contact us.

### General Consideration

All items that are sensitive to sediment must remain valved off and by-passed throughout the flushing procedure. Care should be taken to ensure that pumps are not allowed to operate against a closed head for long periods. This situation should be avoided whenever possible.

### CHEMICAL CLEANING

Chemical cleaning should always be carried out immediately after flushing.

Chemical cleaning of the system should always be the responsibility of the appointed chemical cleaning specialist and should be preceded by a properly executed clean water flushing as described in the previous section. This is an essential pre-requisite to any effective chemical cleaning programme.

There are many proprietary cleaning chemicals available for preparing the pipework for subsequent service. Some of these are acidic, others are neutral but all must be capable of effectively removing any rust and other debris that has formed in the pipework prior to commissioning, without damaging the various components in the system.

Strong acid cleaners that do not contain inhibitor must be avoided as severe internal wastage may occur, particularly at joints between tube and fitting.

Irrespective of whatever cleaner is chosen, the manufacturer's instructions must be followed exactly, taking particular care to ensure that cleaning agents are completely flushed out of the system before adding any protective inhibitors to the water.

Please refer to BSRIA BG29 2012

'Pre-Commission Cleaning of Pipework Systems'.

As this is specialist work, it should only be entrusted to an organisation that has the facilities, safety training and experience in dealing with the potentially hazardous chemicals involved. Suitably qualified personnel will have the knowledge to be able to offer advice on the selection and use of appropriate chemicals, as well as the safe disposal of waste material.

### PRESSURE TESTING OF PIPEWORK SYSTEMS

It is recommended that completed pipework systems are pressure tested prior to being covered (insulation, or paint), and should be performed prior to commencing the cleaning procedure.

The entire system should be pressure tested in accordance of BSRIA and B&ES.

This pressure test can be both pneumatic and hydraulic and is determined by the installed and planned commissioning regime.

If the pipe system is to be left empty after the pressure test, then a pressure test with dry air and/or inert gas should be performed, (microbiological contamination through bacteria and corrosion of carbon steel systems has to be avoided).

The pressure test should consist of two steps;

- ✚ Leak test
- ✚ Tightness test

The leak test involves inspecting the system for joint integrity (tightness), the tightness test focuses on checking the system for strength.

The tightness test with water is described in the B&ES Guide to Good Practice TR/6, BS EN 806-4, BS6700.

If pre-fabricated pipework or equipment has been hydraulically pressure tested, off site prior to installation, this should be notified to the cleaning/chemical treatment specialist as these may have already developed an internal layer of corrosion, microbiological, biofilm build up etc.

Due to the inherent dangers associated with pneumatic testing using inert gas or dry air a responsible person must be in charge of this operation at all times.

The following must be understood as a recommendation only.

### BASIC PROCEDURE

If the system is to be pressure tested (as recommended) then the following procedure applies to each section in turn.

#### 1. Test Preparation

- a. Check that all high points have suitable vents to facilitate removal of air during filling and that these are all closed.
- b. Install suitable drainage facilities at all low points for drainage.
- c. Blank plug or seal any open ends and close all valves at the limits of the test section of the piping
- d. Remove, blank off all terminal units that may be damaged by the test pressure.
- e. Open all valves within the enclosed test section.
- f. Check that the test gauge is working correctly and has been calibrated, and has the correct range.
- g. If the compressed dry air or inert gas is at a higher pressure than is required for the test (maximum 0.5bar pressure) a pressure reducing valve, pressure gauge and pressure relief valve set to open at the test pressure should be fitted to the connecting pipework.
- h. If possible the compressed air supply should be outside the test area
- i. Check that there is a suitable method for draining the system.

It is recommended that systems be tested with a nitrogen rich (90%)/ air mixture. If air is to be used it should be clean, dry and free from oil, the drying performance should conform to 'purity class 3 under the ISO 8573' for particulate contamination, water and oil content.

Guidance should be sought from the relevant compressor manufacturer.

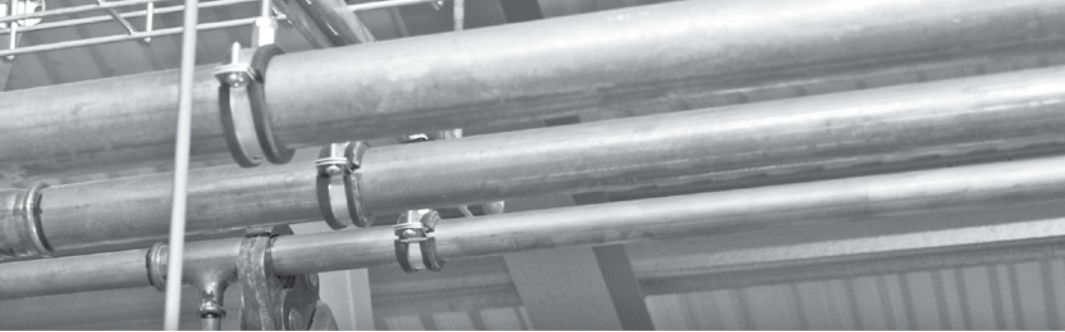

Excessive oil carry over in compressed air may be detrimental to the EPDM seals as well as causing bacteriological issues. Pure Nitrogen is also acceptable but consideration should be taken of HSE guidelines or recommendations.

## 2. Pneumatic Pressure Testing

- a. An initial low-pressure test at 0.5 bar is to be carried out, having put the necessary safety measures in place, to enable any leaks to be found.  
Significantly leaking, un-pressed or damaged joints shall be replaced, but those with low leakage rates should be identified for close inspection during the high-pressure test.
- b. This test pressure is to be maintained / pumped for a period of 30 minutes minimum.
- c. The test is passed if the pressure in the system is maintained for one hour and there is no visible leakage throughout the test.
- d. If required, a signature should be obtained on a test certificate.
- e. After testing, safely release the pressure, if necessary ensure that all vents on cylinder tanks and pressure vessels are opened to atmosphere BEFORE draining down and refitting vulnerable items.

These test times may vary according to the pipework system (plastic pipe systems may take longer to achieve stable pressures).

Water Regulation 12 requires 'that the water system shall be capable of withstanding an internal water pressure not less than 1.5 times the maximum pressure to which the installation or relevant part is designed to be subjected to in operation'.

When hydraulic testing is undertaken then the following should be carried out.

The test water should contain anti-corrosion inhibitors / long lasting biocide chemicals with the intention that post testing the system shall be left completely full of the test water (suitable protection against freezing and the onset of biological growth will also have to be considered). Circulation of the system test is strongly recommended.

If leaving the system full of water is not practical then every effort shall be made to fully drain and dry the pipe work by purging with dry air/ nitrogen. If the system is to be left not in use for longer than 5 days, we recommend that the system be left charged with an inert gas to reduce the risk of onset corrosion and /or bacterial growth.

Do not leave a Carbon Steel system empty without drying as oxygen will begin to corrode the internal surface.

Inspection of the internal condition to the pipework is recommended so that the water treatment specialist understands the correct process required when cleaning.

## 3. Hydraulic Pressure Testing

- a. Start to fill the system and 'walk' the route of the pipework being tested. Visually checking for leaks and listening for the sound of escaping air.
- b. Release air from all the high points systematically through the system to ensure the system is completely filled with water. (The full loading of the o rings often resolves small leaks identified during the 0.5 bar test).

- c. Turn the pump on to allow the system water to circulate to help reduce the risk of trapped air, bleed the system if necessary. Turn off the pump set when completed.
- d. Check the system contains the correct amount of inhibitors and biocides.
- e. Using an independent pump set, progressively increase the pressure until the system pressure achieves 1.5 times normal working pressure, (verify that this pressure is within the capability of the system components), record the test pressure.
- f. Leave the system for 30 minutes minimum.
- g. The test is passed if the pressure in the system is maintained for the next one hour and there is no visible leakage throughout the test.
- h. Leaking joints at this stage should be identified and marked for replacement.
- i. The system pressure should then be reduced to 0.5 bar again to confirm that no persistent low-pressure leaks are present.

Further information can be found in;

Guides issued by BSRIA, B&ES, CIBSE, WRAS and the Copper Development Association (CDA) Guideline document 'Pressure Testing Piping Systems'.

## PRESSURE TEST FOR NATURAL GAS SYSTEMS

**Important:** The pressure test for natural gas and liquid gas systems must be performed in accordance with local regulations.

## PRESSURE TEST OF SPRINKLER SYSTEMS

The tubes of the sprinkler system must be subjected to a pressure test in accordance with valid guidelines, such as CEA 4001, no. 17.1.1. (VdS) for at least two hours. A pressure (measured at the alarm valves) corresponding to 1.5 times the permitted positive operating pressure – but of at least 15 bars – must be maintained during the test. This pressure test is a check of both the strength and tightness of the system. The system must be monitored for 24 hours for any pressure drop due, for example, to temperature changes. Dry sprinkler systems must also be tested pneumatically to a pressure of not less than 2.5 bars for at least 24 hours. Any leakage, which occurs and results in a pressure drop of more than 0.15 bar over the 24 h, must be corrected.

Any faults identified, such as permanent deformations, ruptures or leakages must be corrected and the pressure test repeated.

## TUBE BENDING

Portable bending machines are ideal for bending tubes up to 28mm. Most machines bend the tube between matched formers and back guides that support the outside diameter (OD) of the tube. This eliminates the risk of the tube wall collapsing.

The point at which the bending pressure is exerted must be maintained at the correct distance in front of the former's point of support. It's also important to keep formers and guides well lubricated. Bending tubes correctly will avoid any wrinkling and flattening that can affect flow conditions.

Using adjustable bending machines (which allow the pressure on the back guide to be adjusted) will ensure perfect bends every time so long as the root (inside) bending radius is 3.5 times the outside diameter of the tube. Up to 28mm Carbon and Stainless and 54mm Copper.

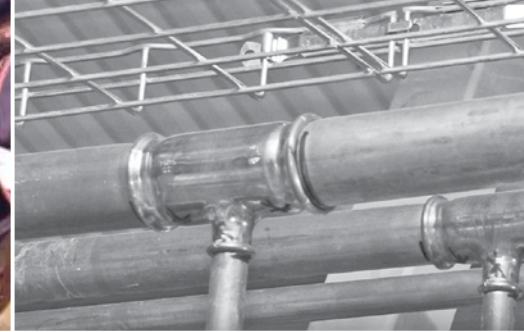

## 3.0 TECHNICAL DATA

# SYSTEM DESIGN CONSIDERATIONS AND TUBE EXPANSION

A wide range of tube is offered for use with the XPress System covering a wide range of applications.

**NOTE: The bending of SS610 Stainless Steel tube manufactured to table 1, is not recommended.**

However XPress Stainless tube, manufactured to table 2 shall be the preferred tube for bending in sizes up to 28mm.

With the bending of carbon tube it is important to ensure the weld seam is kept to the inside radius of the bend.

### CARBON STEEL SYSTEM TUBE: BENDS

Size	Minimum Radii
15mm	53mm
18mm	63mm
22mm	77mm
28mm	98mm

In sizes up to 28mm Carbon Steel System tube, is suitable for bending using proprietary bend formers.

#### Important:

XPress fittings must not come into contact with household cleaning products, paints, greases, fluxes, mineral oils, adhesives or other solvent based materials that may be used during installation, lagging or after installation. These materials may affect the O rings in XPress fittings. XPress fittings should not be painted.

### XPRESS 'LEAK BEFORE PRESS'

XPress Copper, XPress Carbon, XPress Stainless and XPress Solar offer a unique 'Leak Before Press' feature (LBP) which enables any connections which haven't been pressed to be easily identified during pressure testing at pressures as low as 0.5bar.



### XPRESS CARBON AND XPRESS STAINLESS

The LBP feature on both XPress Carbon and XPress Stainless (sizes 15mm-54mm) is created by the use of a specially profiled EPDM O ring.

The LBP O rings have been specially designed to incorporate a series of three grooves in its surface through which water will leak from any un-pressed fitting. When pressed, the O ring distorts, closing the grooves to create a fully water-tight and air-tight connection.



### XPRESS COPPER / XPRESS SOLAR

Whilst the mechanical properties of XPress Copper with LBP are different, the benefits are the same. The softer nature of copper enables the LBP feature to be incorporated into the O ring bead in the fitting. The bead is slightly triangular in shape and this creates three spaces between the fitting and the tube through which water will leak if the fitting is not pressed. One additional advantage of this system is that there is still sufficient contact between the O ring and the tube to prevent it moving when inserted. When pressed the shape of the O ring bead is transformed from its triangular shape to a round shape which, once again, is perfectly water-tight and air-tight.

### GAS O RINGS (AND O RINGS)

Pegler Yorkshire does not recommend O rings are removed from the standard product and replaced with a gas O ring. To prevent this gas O rings are not offered as spares within the XPress accessories range. We only recommend gas fittings are purchased as fully assembled products. We also do not recommend that gas O rings are removed and replaced with standard O rings.

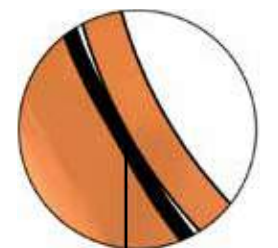
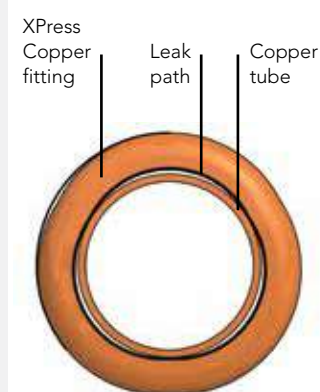

Note: Contact between O ring and tube, to maintain tube grip  
Contact between tube, O ring and fitting which fixates the tube

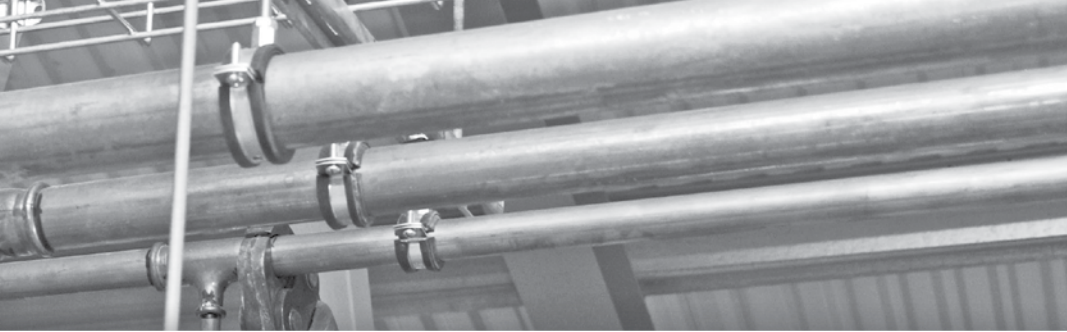

**XPRESS COPPER AND CARBON / STAINLESS WHEN USED WITH COMPRESSED AIR**

**XPRESS COPPER (BLACK EPDM O-RINGS - S100)**

**Compressed air installation**

XPress Copper fittings manufactured copper, copper alloys, which fulfill EN 1254 can be used for compressed air if the following conditions are observed:

**Oil contents:** Max. 25 mg/m<sup>3</sup>, class 5, ISO 8573 part 1

**O-rings:** EPDM (black) can only be used for synthetic oil or dry compressed air (not exceeding 25 mg/m<sup>3</sup>).

**Operating temperature:** -20 to +110°C

**Operating pressure:** Max. 16bar

XPress Copper fittings with copper tubes which fulfill EN 1057 R250/ R290.

**XPRESS COPPER GREEN FPM (VITON® O-RINGS - SV100)**

**Compressed air installation**

XPress Copper fittings manufactured copper, copper alloys, which fulfill EN 1254 can be used for compressed air if the following conditions are observed:

**Oil contents:** Greater than 25 mg/m<sup>3</sup>, class 5, ISO 8573 part 1

**O-rings:** Viton (green) can only be used for synthetic oil or dry compressed air (exceeding 25 mg/m<sup>3</sup>).

**Operating temperature(\*):** -20 to +200°C

**Operating pressure:** Max. 16bar

(\* ) For short time exposure, refer to the exposure table page 135.

XPress Copper fittings with copper tubes which fulfill EN 1057 R250/ R290.

**XPRESS CARBON AND STAINLESS STEEL (BLACK EPDM O-RINGS - SS100)**

**Compressed air installation**

XPress Carbon fittings with zinc plated precision carbon steel tubes which fulfill EN 10305-3 or XPress Stainless fittings with stainless steel tube which fulfill EN10312 XPress Carbon fittings with zinc plated precision carbon steel tubes can be used for compressed air if following conditions are observed:

**Water contents:** Max. 880 mg/m<sup>3</sup>, class 3, ISO 8573 part 1

**Oil contents:** Max. 25 mg/m<sup>3</sup>, class 5, ISO 8573 part 1

When exceeding the maximum water content then copper or stainless steel should be used.

**O-rings:** EPDM (black) can only be used for synthetic oil or dry compressed air (not exceeding 25 mg/m<sup>3</sup>).

**Operating temperature:** -35 to 135°C

**Operating pressure:** Max 16bar 12 to 54mm. Max 10bar 66.7 to 108mm.

XPress Carbon fittings with XPress carbon tubes which fulfill EN 10305-3.

XPress Steel fittings with XPress steel tubes which fulfill EN 10312.





## 3.0 TECHNICAL DATA

# SYSTEM DESIGN CONSIDERATIONS AND TUBE EXPANSION

### XPRESS CARBON AND STAINLESS STEEL GREEN FPM (VITON® O-RINGS - SV105)

#### Compressed air installation

XPress Carbon fittings with zinc plated precision carbon steel tubes which fulfill EN 10305-3 or XPress Stainless fittings with stainless steel tube which fulfill EN10312 XPress Carbon fittings with zinc plated precision carbon steel tubes can be used for compressed air if following conditions are observed:

**Water contents:** Max. 880 mg/m<sup>3</sup>, class 3, ISO 8573 part 1

**Oil contents:** Greater than 25 mg/m<sup>3</sup>, class 5, ISO 8573 part 1

When exceeding the maximum water content then copper or stainless steel should be used.

**O-rings:** Viton (green) can only be used for synthetic oil or dry compressed air (exceeding 25 mg/m<sup>3</sup>).

**Operating temperature(\*):** -20 to +200°C

**Operating pressure:** Max 16bar 12 to 54mm. Max 10bar 66.7 to 108mm.

(\* For short time exposure, refer to the exposure table page 135.

XPress Carbon fittings with XPress carbon tubes which fulfill EN 10305-3.

XPress stainless Steel fittings with XPress stainless steel tubes which fulfill EN 10312.

**Important:** On completion, compressed air pipeline systems must be properly tested. The system designer and installation contractor must ensure safe methods are selected for system testing which will comply with all current health and safety regulations. This may include testing compressed air lines with fluids or compressed air at a limited pressure, or a combination of both.

After the installation the compressed air installation should be pressure tested according the valid local guide lines. In any event we do not recommend the maximum working pressure of the product to be exceeded during this procedure.

#### O RING COMPATIBILITY CHART

XPress fittings use the same O Ring technology to provide the best and widest range of heat free jointing systems. It is important to check compatibility between the O Ring and the fluid in the system. The table below is a guide for the contractor, installer and specifier, and shows the compatibility of three O Ring materials with common fluid types and some gases.

EPDM - Ethylene Propylene Diene Monomer - This is the standard, black O Ring that is used in XPress ranges.

HNBR - Hydrogenated Nitrile Rubber - This is the yellow O Ring that is only used in XPress Gas.

FPM - Fluorocarbon Rubber - This is the green O Ring that is only used in XPress Solar.

These tables refer to room temperature test. The performance of O Rings is influenced by the type of system, transported medium, temperature range, pressure range and external factors. This table is provided as a general guide, however, for specific queries concerning compatibility we suggest you contact the Pegler Yorkshire technical department.

	Black	Yellow	Green
Designation	EPDM - XPress	HNBR Gas	FPM Solar
Maximum service temperature °C	180	100	230
Low service temperature °C	-50	-20	-20
Water/Steam Resistance			
Water/Steam resistance <40°C	✓ ✓ ✓	✓ ✓ ✓	✓ ✓ ✓
Water/Steam resistance <80°C	✓ ✓ ✓	✓ ✓	✓ ✓ ✓
Water/Steam resistance <150°C	✓ ✓	x	✓ ✓
Water/Steam resistance >150°C	✓	x	✓ ✓

	Black	Yellow	Green
Designation	EPDM - XPress	HNBR Gas	FPM Solar
<b>Fluids Resistance</b>			
<b>Acid</b>			
Acetic 10%	✓ ✓ ✓	✓	✓
Formic	✓ ✓ ✓	x	✓
Hydrochloric 20%	✓ ✓ ✓	✓	✓ ✓
Nitric 30%	✓ ✓ ✓	x	✓ ✓
Phosphoric 20% †	✓ ✓	✓	✓ ✓ ✓
Sulphuric 30% †	✓	x	✓ ✓
<b>Alkalis</b>			
Barium hydroxide	✓ ✓ ✓	✓ ✓	✓ ✓ ✓
Calcium hydroxide	✓ ✓ ✓	✓ ✓	✓ ✓ ✓
Sodium hydroxide	✓ ✓ ✓	✓ ✓	✓ ✓
<b>Alcohols</b>			
Butyl alcohol (Butanol)	✓ ✓	✓ ✓ ✓	✓ ✓ ✓
Ethyl alcohol (Ethanol)	✓ ✓ ✓	✓ ✓	✓
Methyl alcohol (Methanol)	✓ ✓ ✓	✓ ✓ ✓	
<b>Amines</b>			
Ethylene diamine	✓ ✓ ✓	✓ ✓	x
Ammonia – cold gas	✓ ✓ ✓	✓ ✓ ✓	x
Ammonia – hot gas	✓ ✓	x	x
<b>Chlorides</b>			
Ammonium chloride	✓ ✓ ✓	✓ ✓ ✓	✓ ✓ ✓
Calcium chloride solution	✓ ✓ ✓	✓ ✓ ✓	✓ ✓ ✓
Magnesium chloride	✓ ✓ ✓	✓ ✓ ✓	✓ ✓ ✓
Zinc chloride	✓ ✓ ✓	✓ ✓ ✓	✓ ✓ ✓

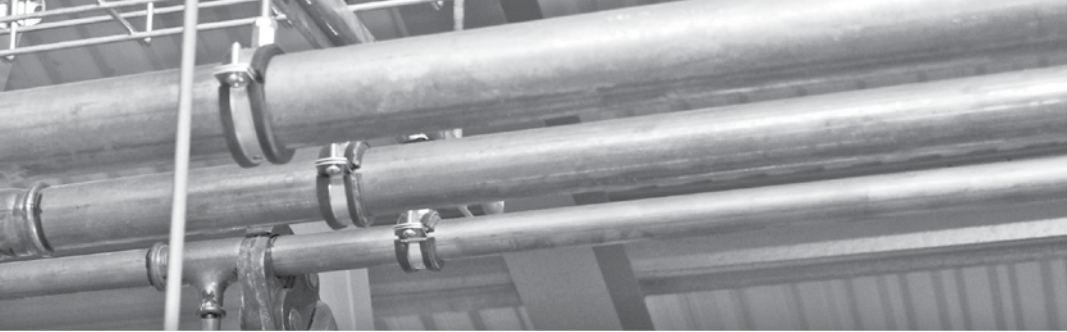

## CONNECT + CONTROL

Designation	Black EPDM - Tectite / XPress	Yellow HNBR Gas	Green FPM Solar
<b>Gases</b>			
Butane	x	✓ ✓ ✓	✓ ✓ ✓
Carbon dioxide (dry)	✓ ✓	✓ ✓ ✓	✓ ✓ ✓
Chloride (wet)	✓	x	✓ ✓ ✓
Freon 12	✓ ✓	✓ ✓ ✓	✓ ✓ ✓
Freon 21	x	x	x
Freon 22	✓ ✓ ✓	x	x
Freon 134a	✓ ✓ ✓	•	x
Natural gas	x	✓ ✓ ✓	✓ ✓ ✓
Methane	x	✓ ✓ ✓	✓ ✓ ✓
Propane	x	✓ ✓ ✓	✓ ✓ ✓
<b>Oils and Fuels</b>			
ASTM No 1 oil	x	✓ ✓ ✓	✓ ✓ ✓
ASTM No 2 oil	x	✓ ✓ ✓	✓ ✓ ✓
ASTM No 3 oil	x	✓ ✓ ✓	✓ ✓ ✓
ASTM fuel A	x	✓ ✓ ✓	✓ ✓ ✓
ASTM fuel B	x	✓ ✓ ✓	✓ ✓ ✓
ASTM fuel C	x	✓	✓ ✓ ✓
Diesel oil	x	✓ ✓ ✓	✓ ✓ ✓
Diesel oil + RME (10%)	x	x	✓ ✓ ✓
Mineral oil (low aromatic)	x	✓ ✓ ✓	✓ ✓ ✓
Hydraulic oils (petroleum base)	x	✓ ✓ ✓	✓ ✓ ✓
Lubricating oils	x	✓ ✓ ✓	✓ ✓ ✓
Paraffin	x	✓ ✓ ✓	✓ ✓ ✓
Petrol	x	✓ ✓	✓ ✓ ✓
Silicone oil/grease	✓ ✓ ✓	✓ ✓ ✓	✓ ✓ ✓
Transformer oils	x	✓ ✓ ✓	✓ ✓ ✓
Vegetable oils	✓	✓ ✓ ✓	✓ ✓ ✓
<b>Solvents †</b>			
Acetone	✓ ✓ ✓	x	x
Benzene	x	x	✓ ✓ ✓
Carbon tetrachloride	x	✓	✓ ✓ ✓
Dimethyl formamide	✓ ✓	✓	x
Ethyl acetate	✓ ✓	x	x
Methyl ethyl ketone	✓ ✓ ✓	x	x
Tetrachloroethylene	x	x	✓ ✓ ✓
Toluene	x	x	✓ ✓ ✓
Turpentine	x	✓ ✓ ✓	✓ ✓ ✓
Xylene	x	x	✓ ✓
<b>Miscellaneous</b>			
Ethylene glycol	✓ ✓ ✓	✓ ✓ ✓	✓ ✓ ✓
Detergents	✓ ✓ ✓	✓ ✓ ✓	✓ ✓ ✓
Diocetyl phthalate	✓ ✓	x	x
Formaldehyde	✓ ✓ ✓	✓	x
Hydrogen peroxide (90%)	✓ ✓ ✓	x	✓ ✓
Phosphate esters	✓ ✓ ✓	x	✓ ✓
Potassium nitrate	✓ ✓ ✓	✓ ✓ ✓	✓ ✓ ✓

### KEY TO MEDIA TABLE

✓ ✓ ✓	Excellent – Recommended
✓ ✓	Good – Minor to moderate effects
✓	Fair – Moderate to severe effects
x	Poor – Not recommended
•	Insufficient data available
† Conditions Apply	Temperature or other limitation affecting polymer choice

### O RINGS - XPRESS COPPER

EPDM S100 O Ring for use with XPress Copper fittings only	Temperature	Applications
XPress Copper Systems	-20 to 110°C	Potable water, Heating, Cooling

SV100 Viton O Ring For use with XPress Copper fittings only	Temperature	Applications
XPress Copper Systems	-20 to 200°C	Solar applications refer to exposure table*

### O RINGS - XPRESS STAINLESS STEEL AND CARBON SYSTEMS

EPDM S100 O Ring for use with XPress Copper fittings only	Temperature	Applications
XPress Stainless Systems	-35 to 135°C	Potable water, Sprinkler
XPress Carbon Systems	-35 to 135°C	Heating, Cooling, Sprinkler

  

SV100 Viton O Ring for use with XPress Stainless and Carbon fittings only	Temperature	Applications
XPress Carbon and Stainless Systems -20 to 200°C	Solar applications refer to exposure table*	Solar applications refer to exposure table*

### \*SOLAR EXPOSURE TABLE

Temperature	Durability	Pressure	Working condition
200°C	Cumulative exposure 20hrs/year	3bar	Normal operating pressure
180°C	Cumulative exposure 60hrs/year	10bar	Maximum working pressure
150°C	Cumulative exposure 480hrs/year	16bar	Maximum test pressure
90 - 130°C	Normal working temperature	16bar	Maximum surge pressure
-20°C	Winter temperature	16bar	Maximum surge pressure

For more details on O ring compatibility visit:  
[www.peglerYorkshire.co.uk](http://www.peglerYorkshire.co.uk)

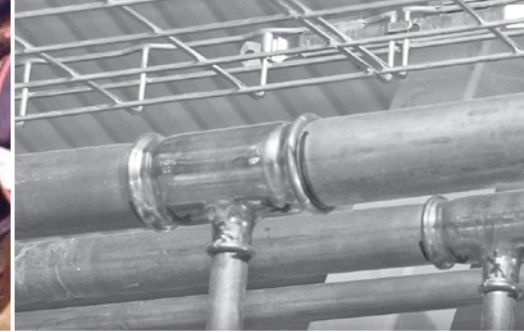

## 3.0 TECHNICAL DATA

# SYSTEM DESIGN CONSIDERATIONS AND TUBE EXPANSION

### CONNECTING TUBES MADE FROM DISSIMILAR METAL

The UK Water Regulations recommend that tubes and fittings made from different types of metals shall not be connected directly together except where galvanic action is unlikely or where effective measures are taken to prevent it. Galvanic corrosion is a process whereby the materials that come in to contact with each other oxidises or corrodes. If you are in doubt, we recommend you refer to the full and detailed information provided in Water Regulations Guide (G2.11 and R3.2), or by contacting the Water Regulations Advisory Scheme [info@wras.co.uk](mailto:info@wras.co.uk).

### MIXED METAL INSTALLATIONS

The substitution of stainless steel XPress or Tectite 316 fittings on a galvanised carbon steel installation is acceptable in heating and chilled water applications, if required.

When joining copper to carbon steel we recommend the use of a yellow metal i.e. brass or gunmetal to prevent galvanic corrosion.

When doing this, care must be taken to protect the SC640 galvanised tube surface from the increased risk of external corrosion at the stainless/galvanised steel interface.

Galvanised carbon steel is anodic to stainless steel in air and, if the pipeline is allowed to become wet, there is a risk of localised corrosion of the carbon steel tube surface adjacent to the stainless steel fitting. This potential problem is less likely in heating pipe work which usually remains hot and dry.

In chilled water installations, an accumulation of environmental condensate on the pipe work could, under some circumstances, leach out aggressive chemicals from the insulation, resulting in corrosion, particularly at the stainless steel/carbon steel interface. Consequently, we recommend that where stainless steel fittings are installed on carbon steel pipe, the joint area should be provided with additional protection to prevent localised corrosion. This can be as simple as wrapping the interface area with an impervious material such as Denso or PVC tape.

Provided these precautions are taken, there is no reason why the combination of stainless steel fittings and carbon steel tube should not be entirely satisfactory. Provided used on closed system.



### SPRINKLER SYSTEMS



LPS 1234: Issue 1  
Cert No. 1033a & 1033b

#### XPRESS SPRINKLER STAINLESS LPCB

The XPress Sprinkler Stainless System (22-54mm) has approval for application in wet sprinkler systems with a maximum pressure of 16bar. Accordingly LPCB system is certified for using XPress stainless steel tubes with material code 1.4401 (AISI 316), 1.4520 (AISI 439) and 1.4521 (AISI 444). XPress Sprinkler Stainless is WRAS approved in combination with 1.4401 tubes.

#### XPRESS SPRINKLER GALVANISED LPCB

The XPress Sprinkler Galvanized System (22-54mm) has approval for the application in wet sprinkler systems with a maximum working pressure of 16bar.



#### XPRESS SPRINKLER STAINLESS <FM>

The XPress Sprinkler Stainless System (22-54mm) has approval for application in wet and dry sprinkler system with a maximum pressure of 175 psi (12.1bar).

#### XPRESS SPRINKLER GALVANISED <FM>

The XPress Sprinkler Galvanized System has approval for application in wet sprinkler systems with a maximum pressure of 175 psi (12.1bar).

### GAS FAMILIES

There are three gas families:

- ✚ 1st Family - manufactured gas
- ✚ 2nd Family - natural gas
- ✚ 3rd Family - LPG, compressed propane and butane gas

XPress Copper Gas and Stainless Gas do not have the LBP feature for safety reasons and are designed for use in internal and external above ground 2nd and 3rd family gas services.

**XPress gas fittings are not leak before press.**

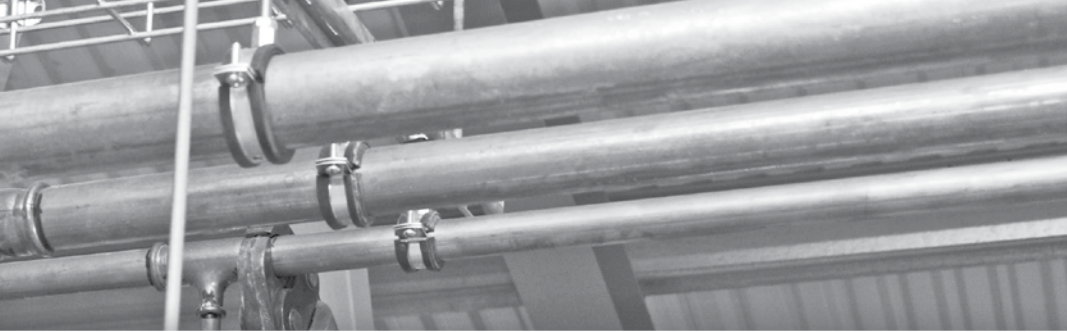

## 4.0 INSTALLATION INSTRUCTIONS

# INSTALLATION SPACING FOR 15MM TO 108MM SIZES

CONNECT + CONTROL

The XPress jointing system has been designed with easy, efficient installation in mind. XPress Copper, XPress Stainless, XPress Carbon, XPress Copper Gas, XPress Stainless Gas and XPress Solar have common installation instructions.

### GUIDE TO INSTALLATION

Jointing procedures are almost identical for every type of XPress fitting and compatible tube material. This includes XPress fittings with 'Leak before Press' (LBP). Where there are variations these are shown on the following pages and in the fitting instructions.

To ensure the fittings stay clean and the O ring remains protected from damage, only remove the fitting from its packaging immediately prior to installation.

The tube can be fully inserted by hand. A damaged tube end will require excessive force to be used. If this is the case you should check the tube is round and deburred before continuing. Check the O ring is not damaged. XPress fittings with plain male ends must not be used directly with capillary fittings, since heating will damage the non-metallic parts.

Heat should not be applied to XPress fittings, directly or indirectly. They should be disconnected (where applicable) to avoid any possible damage to non-metallic parts if they are to be used on a system in conjunction with capillary fittings. Similarly, reconnection must not be considered until the heated tubes have been allowed to cool. Use pipe clips to secure finished installations and prevent vibration or movement.

### SPACING

Allow sufficient clearance around each fitting to allow press jaws to be attached without hindrance.

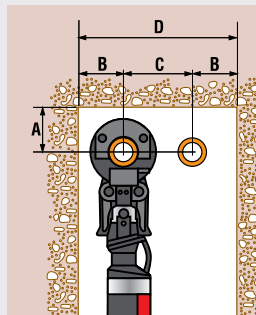
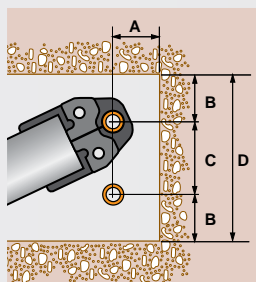
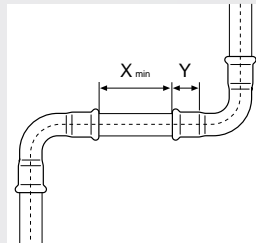

Minimum distances between pressings							
Ø (mm)	Insertion depth			Minimum distance	Minimum tube length		
	Y (mm)			X min (mm)	2 x Y + X min (mm)		
	XPress Stainless (GAS)	XPress Carbon	XPress Copper (GAS)	XPress Stainless (GAS) Carbon, Copper	XPress Stainless (GAS)	XPress Carbon	XPress Copper (GAS)
12	17	17	17	10	44	44	44
15	20	20	20	10	50	50	50
18	20	20	20	10	50	50	50
22	21	21	21	10	52	52	52
28	23	23	23	10	56	56	56
35	26	26	26	10	62	62	62
42	30	30	30	20	80	80	80
54	35	35	35	20	90	90	90
64	-	-	50	30	-	-	130
66.7	-	50	50	30	-	-	130
76.1	55	55	50	55	165	165	140
88.9	63	63	64	65	186	186	193
108	77	77	64	80	234	234	208

Pipework clearance (mm)				
Size	A	B	C	D
15mm	25	28	75	131
18mm	25	28	75	131
22mm	31	35	80	150
28mm	31	35	80	150
35mm	31	44	80	170

Pipework clearance (mm)				
Size	A	B	C	D
42mm	75	75	115	265
54mm	85	85	120	290
66.7mm	100	100	145	345
76.1mm	115	115	165	395
88.9mm	125	125	185	435
108mm	135	135	200	470

### HEALTH AND SAFETY

**1. We recommend that eye protection is worn when operating all pressing tools.**

**2. Do not activate a pressing tool without a fitting in the jaws.**

**Note: When using power tools, great care must be taken at all times. Always refer to the manufacturers' instructions for all machines and tools you use.**

**Refer to the COSHH information for Dri-slide lubricants.**

**Both documents are available at [www.pegleyorkshire.co.uk](http://www.pegleyorkshire.co.uk)**



## 4.0 INSTALLATION INSTRUCTIONS

### XPRESS INSTALLATION INSTRUCTIONS

Select the correct size of tube and fitting for the job. Ensure that both are clean, in good condition and free from damage and imperfections.



#### 1. CHECK THE FITTING

Keep all fittings in their bag prior to installation to ensure the lubrication does not dry out. Ensure the O ring is seated correctly within the fitting socket.

#### 2. CUT THE TUBE SQUARE:

It is essential to cut the tube square using a rotary tube cutter. Pegler Yorkshire recommends using a Rems Cento with the correct cutter wheel for the specific material being cut.

**!** **NOTE: The tube must always be cut completely. Never partially cut and then broken as this could cause corrosion. Do not use a hacksaw, oil cooled saws, abrasive wheels or flame cutting.**

#### ACCEPTABLE METHODS OF CUTTING TUBE INCLUDE:

Rotary tube cutter.

Rems Cento.



**!** **NOTE: Use TC155 for cutting carbon steel tube.**

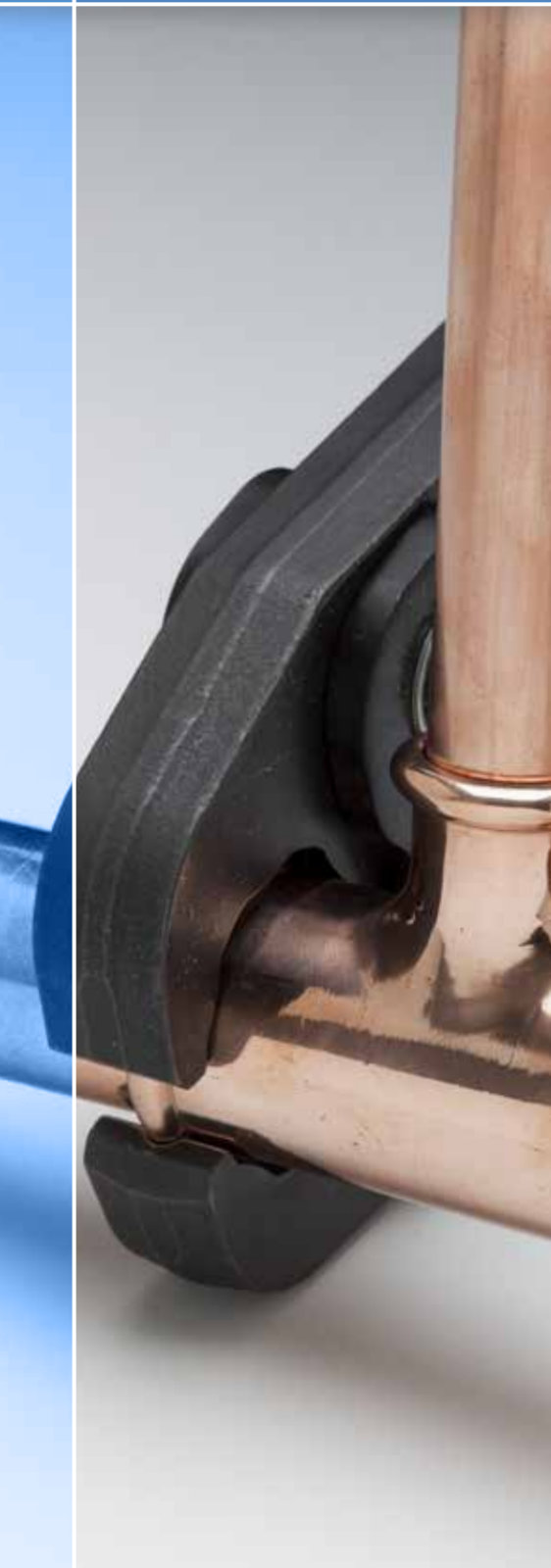

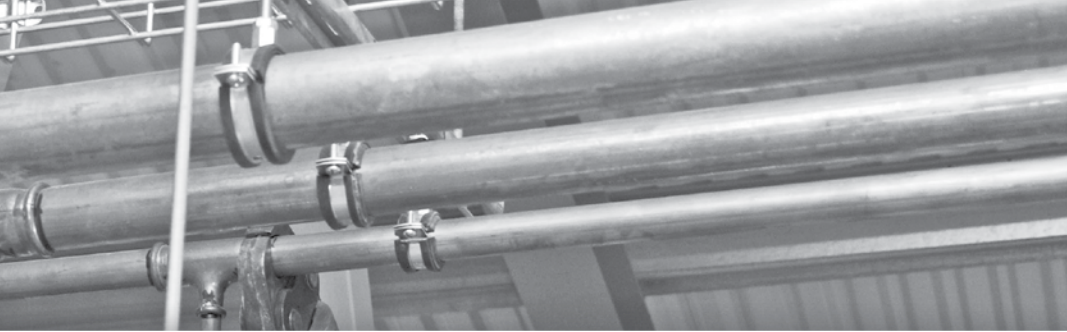

### 3. DEBURR AND CHECK THE TUBE ENDS:

Both the internal and external tube ends should be deburred then wiped clean of all swarf and debris to avoid damage to the O ring upon tube insertion. Also check that the tube end is clean and free from damage such as scores, tape, labels or adhesive residue.

#### ACCEPTABLE METHODS OF DEBURRING INCLUDE:

S120 - 15 to 54mm internal and external.

S122 - 15 to 54mm external only but can re-round damaged tube. Use on copper only.



TC150: 15 - 22mm external only, very good for carbon steel tube. TC143 and TC147 internal only.

Hand file.

**!** NOTE: If using plastic coated carbon steel system tube the plastic coating must be removed from the socket depth of the fitting using the S115 stripping tool from the XPress accessories range.

Use the S115 Tube Stripper for removing the plastic from plastic coated carbon steel tube.

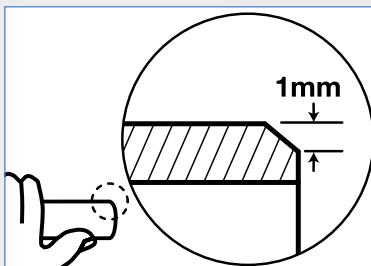

Having deburred as above you will be left with a 1mm chamfer on the outside of the tube as indicated in the diagram. Wipe clean the tube end of remove all swarf and debris.

### PIPEWORK CLEARANCE

When designing an XPress System, please take care to ensure all joints can be accessed easily. Observe minimum gaps and insertion distances to ensure sufficient access for the pressing tool, where applicable.

#### Important:

XPress galvanised Sprinkler system tube (SC645) can only be used in sprinkler installations and should not be used in a general plumbing application.

### SPACING

#### Minimum projection

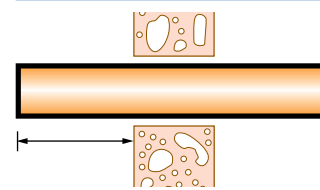

Similar consideration should be given to the distance pipe stubs project through walls or bulkheads. Refer to table on Page 137.

#### Good practice

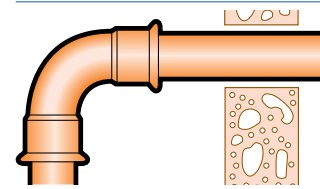

Projection distances shown in the table below also ensure that the subsequent installation will be a convenient distance from the wall.

#### FITTING SPACING FOR XPRESS

Sizes	Min. gap between fittings	Min. tube projection
15mm	10mm	40mm
18mm	10mm	40mm
22mm	10mm	40mm
28mm	10mm	60mm
35mm	10mm	70mm
42mm	20mm	70mm
54mm	20mm	70mm
66.7mm	30mm	70mm
76.1mm	40mm	80mm
88.9mm	50mm	90mm
108mm	50mm	100mm

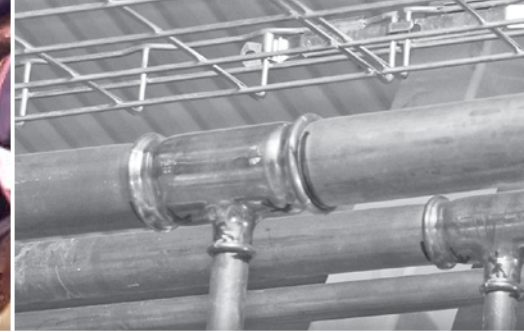

## 4.0 INSTALLATION INSTRUCTIONS

# XPRESS INSTALLATION INSTRUCTIONS

### 4. MARK THE SOCKET DEPTH:

Ensuring full socket depth is achieved is vital for the integrity of the joint. To check that the tube and fitting remains in the correct position throughout the pressing process you must mark the socket depth with a 'V-Tail' mark.



S110 - Orange socket depth tool for Copper tube



S111 - Blue socket depth tool for Carbon and Stainless Steel tube



By hand	
Size	Depth
12mm	17mm
15mm	20mm
18mm	20mm
22mm	21mm
28mm	23mm
35mm	26mm
42mm	30mm
54mm	35mm
66.7mm	50mm
76.9mm (Copper)	50mm
76.9mm (Stainless/Carbon)	55mm
88.9mm	64mm
108mm (Copper)	64mm
108mm (Stainless/Carbon)	78mm



### 5. ASSEMBLE THE JOINT:

Insert the tube into the fitting until it meets the tube stop, using the insertion depth mark as a visual aid.

Only when the tube reaches the tube stop should the pressing operation be commenced.

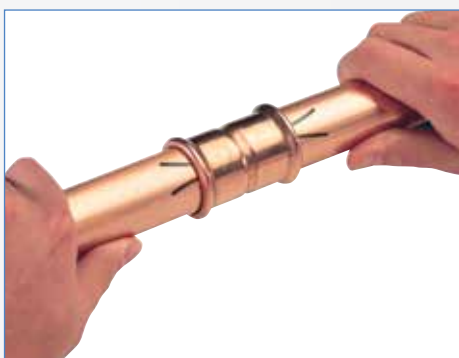

### 6. PREPARE THE PRESS-FIT TOOL:

Select the correct combination of Press-tool, Jaws, Slings and adaptors for the joint being made.

See notes on page 105 regarding 67mm slings and Copper only slings at 108mm.

**!** **NOTE: Always refer to the manufacturer's instructions for detailed information on how to operate your press-tool safely.**

**!** **NOTE: Check that the press tool and relevant jaws/slings have been maintained in accordance with their servicing/calibration schedule.**

Make the tool safe by isolating it from the power supply. Select the correct jaws/sling jaws/sling jaw adaptor for the joint being made, checking that they are free from damage. Attach the jaws/sling jaws/sling jaw adaptor to your press-tool, following the instructions for your particular press-tool, and reconnect the power supply when ready.

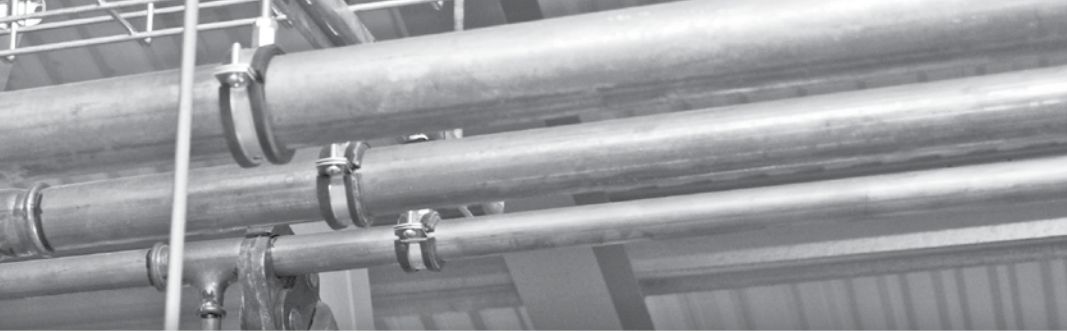

### 7. DRI-SLIDE LUBRICANT

Use of S135 Dri-Slide lubricant is essential when jointing large sized fittings. The pressing profile groove of the sling jaws should be cleaned and lubricated after every 50 joints for 42mm to 76.1mm sizes, and every 5 joints for 108mm. Dri-Slide should also be applied between the main sling arms and the moving segments; and along the pivot pins between the arms. Wipe clean any excess lubricant so that it does not come into contact with the fitting O ring.

**!** NOTE: Dri-Slide lubricant should never be used to lubricate the O ring.



### 8. PRESS THE JOINT:

Mount the jaws/sling jaws over the bead at the mouth of the fitting. With the tool fully supported and not hanging from the pipework, and with your hands safely away from the joint, press the trigger or button to start the jointing cycle. When the jaws/sling jaws fully enclose the mouth of the fitting, the joint is complete. The jaw should then be released from around the fitting.



15 to 35mm.

Pegler Yorkshire recommend the use of Sling Jaws for sizes 42 to 108mm.



**!** NOTE: The 108mm joint is not fully made until the fitting has been through two pressing operations.

**!** NOTE: Maintain a 90° angle between the tube and jaws at all times, this is to ensure the integrity of the joint as well as protect the operator from 'kickback'.

**!** NOTE: The pressing operation should only be carried out when the tube is adequately supported by brackets, not when the tube is suspended in the fitting socket alone.

**!** NOTE: Allow press-fit jaws to be attached without hindrance.

### 9. CHECK THE JOINT:

Inspect the finished joint making sure all is in order, when satisfied the joint has been made correctly mark the joint as complete.

- + The socket depth mark you made indicates that full socket depth has been maintained throughout the pressing cycle.
- + The fitting and pipe bear the witness marks from your jaws/sling jaws.
- + We recommend all systems are thoroughly pressure tested before hand over to end user. Refer to page 110 for detailed recommendations, particularly regarding Carbon Steel installations.

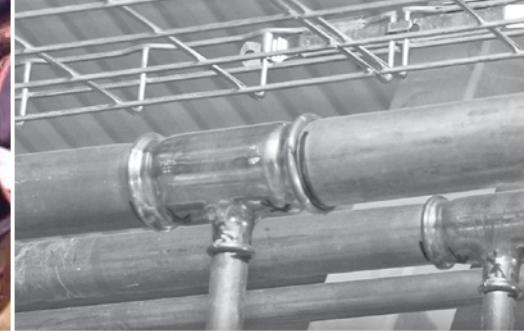

## 5.0

## FLOW CHARTS

**HEAD LOSS /  
PRESSURE  
LOSS  
DIAGRAM:**

**COPPER**

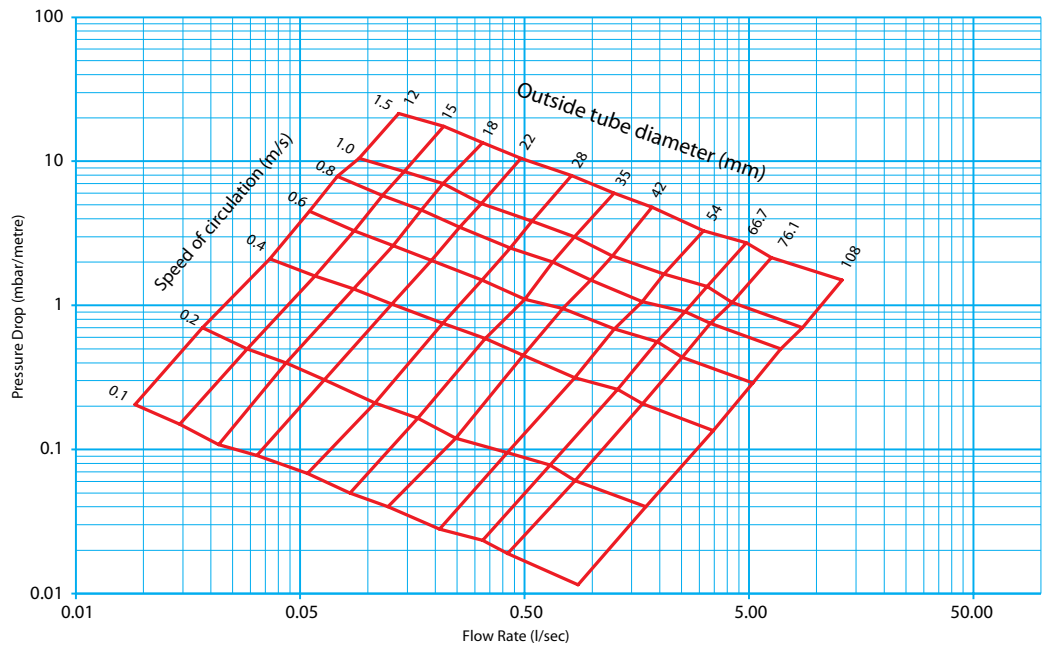

**HEAD LOSS /  
PRESSURE  
LOSS  
DIAGRAM:**

**CARBON STEEL**

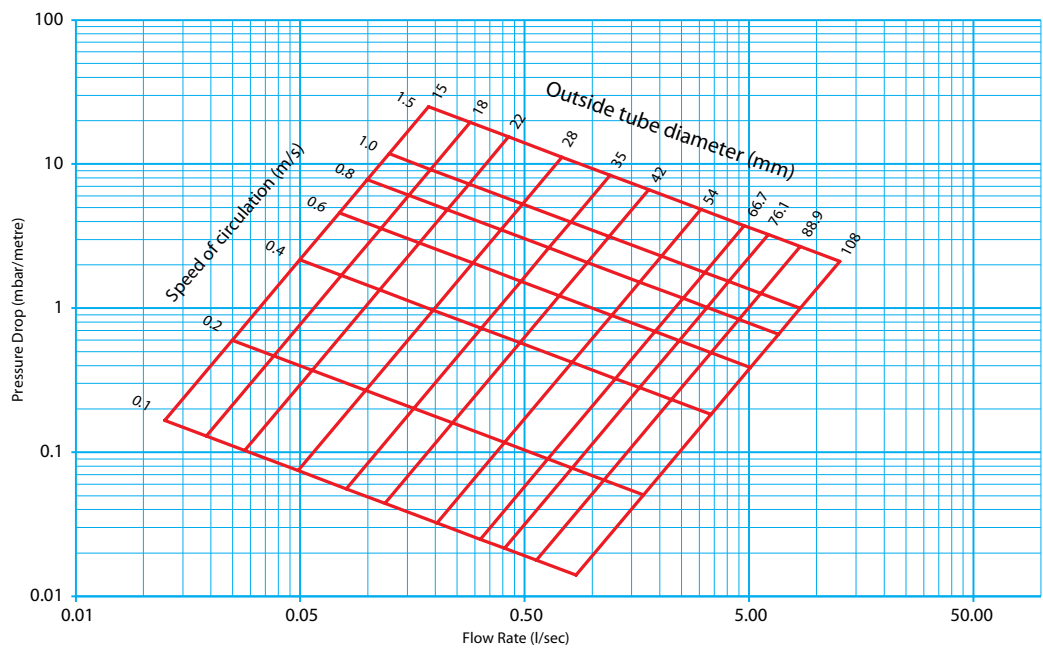



CONNECT + CONTROL

**HEAD LOSS /  
PRESSURE  
LOSS  
DIAGRAM:**

**STAINLESS  
STEEL**

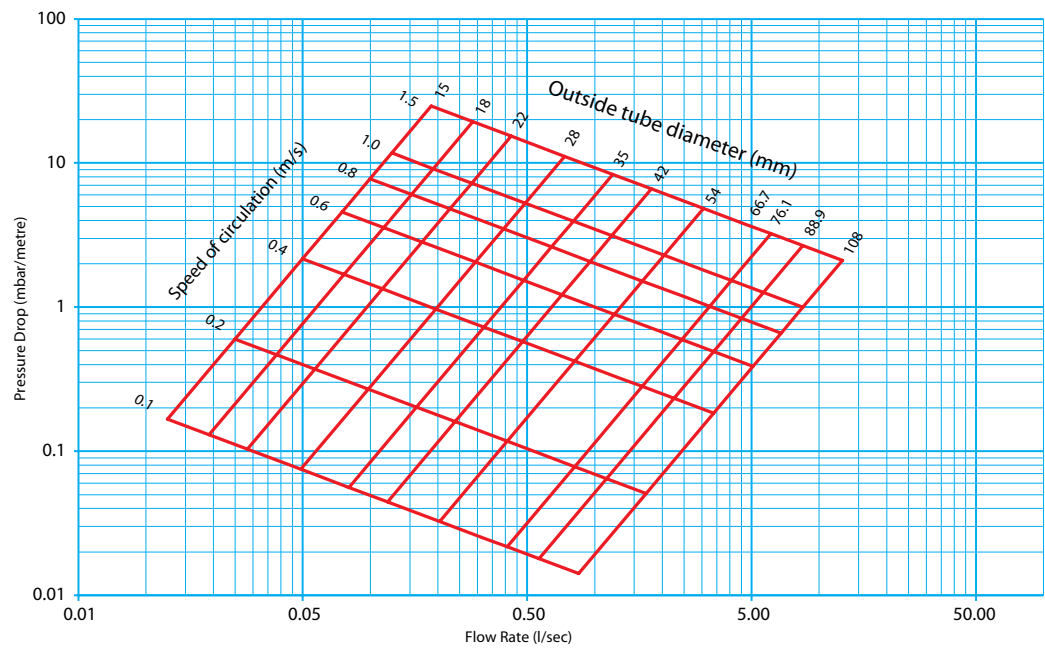

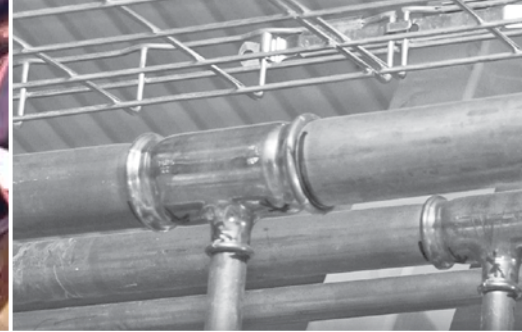

## NOTES

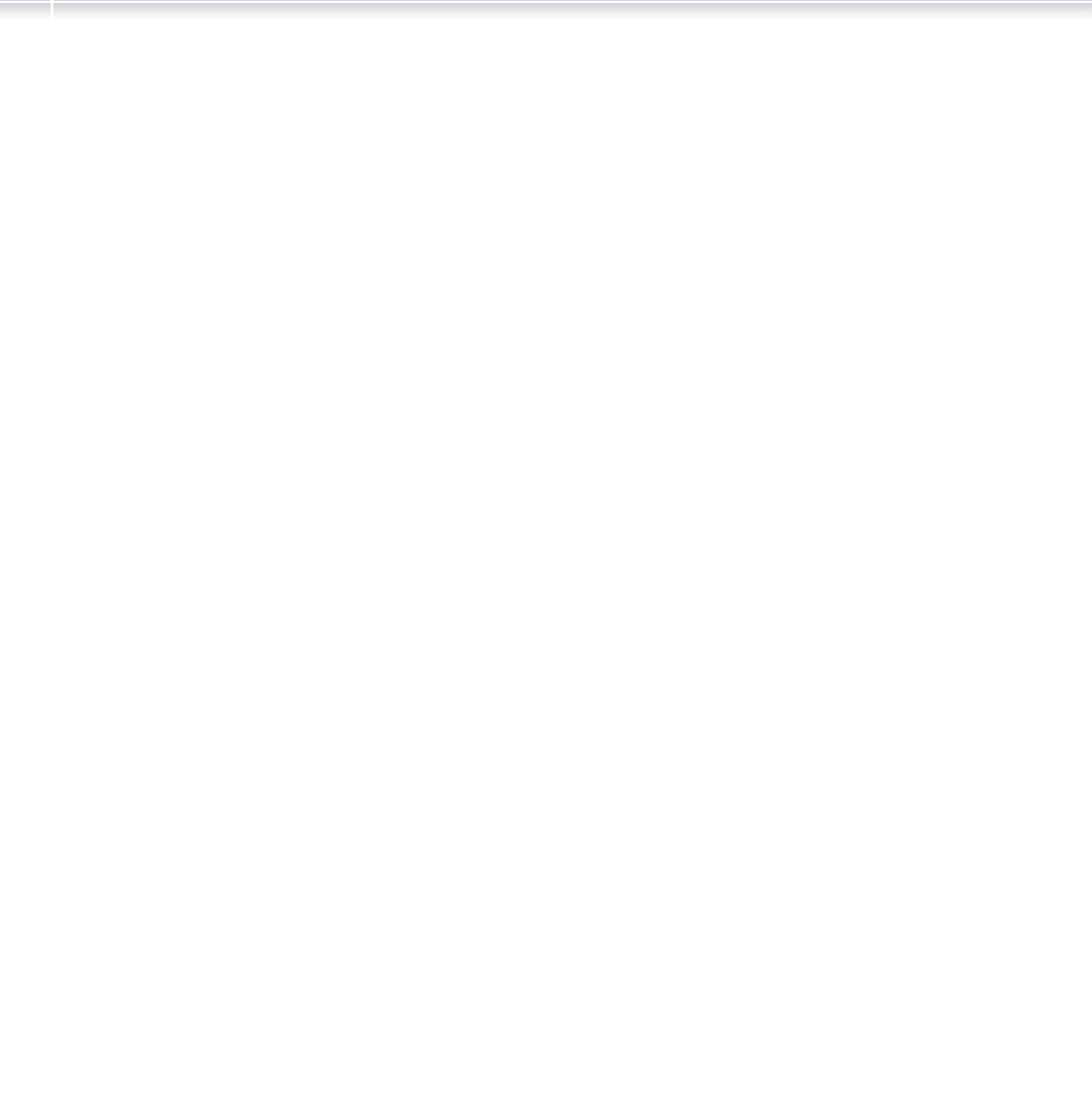
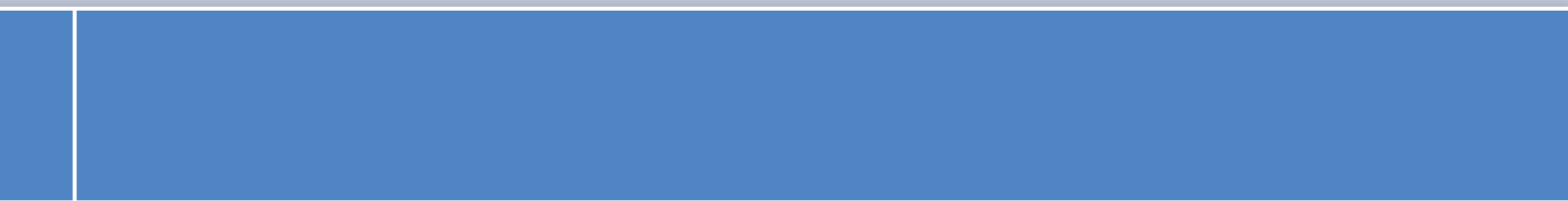
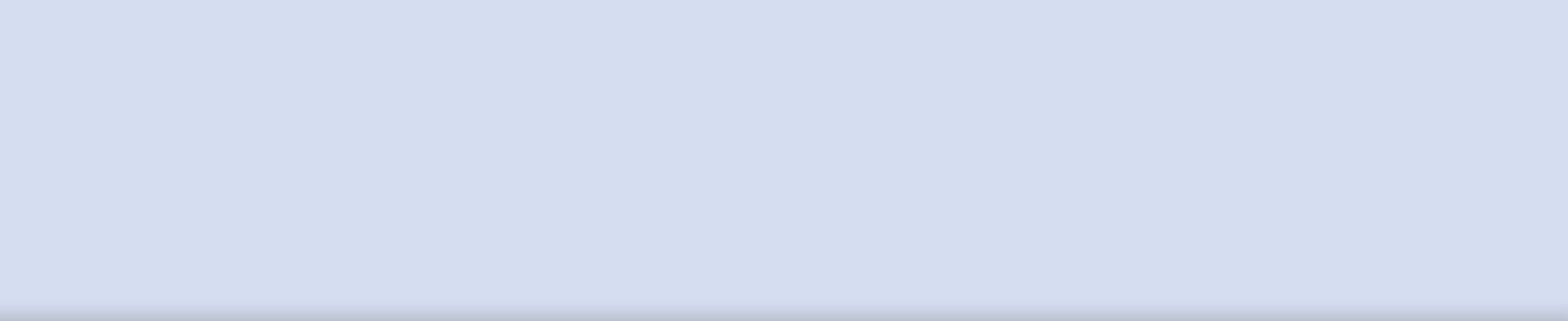



# Pegler Yorkshire

Follow us on



CONNECT  CONTROL

## UK ENQUIRIES

### UK SALES

Free Phone: 0800 156 0010

Free Fax: 0808 156 1011

Email: [uk.sales@pegler-yorkshire.co.uk](mailto:uk.sales@pegler-yorkshire.co.uk)

### TECHNICAL HELP

Free Phone: 0800 156 0050

Free Fax: 0808 156 1012

Email: [tech.help@pegler-yorkshire.co.uk](mailto:tech.help@pegler-yorkshire.co.uk)

### BROCHURE HOTLINE

Free Phone: 0800 156 0020

Free Fax: 0808 156 1011

Email: [info@pegler-yorkshire.co.uk](mailto:info@pegler-yorkshire.co.uk)

## INTERNATIONAL ENQUIRIES

### EXPORT

Tel: +44 (0) 1302 855 656

Fax: +44 (0) 1302 730 513

Email: [export@pegler-yorkshire.co.uk](mailto:export@pegler-yorkshire.co.uk)

**Tectite**

**XPress**

**Henco**

**Terrier**

**Meibes**

**Ballorex**

**Pegler**

**Prestex**

**Yorkshire**

**Endex**

**Kuterlite**

**Francis Pegler**

**Performa**



## HEAD OFFICE

### Pegler Yorkshire Group Limited

St. Catherine's Avenue, Doncaster,  
South Yorkshire DN4 8DF, England

Tel: +44 (0) 844 243 4400

Fax: +44 (0) 844 243 9870

Email: [info@pegler-yorkshire.co.uk](mailto:info@pegler-yorkshire.co.uk)

[www.pegler-yorkshire.co.uk](http://www.pegler-yorkshire.co.uk)

Registered in England Company No. 00401507

Registered Office: Haigh Park Road, Stourton,  
Leeds, West Yorkshire, LS10 1RT England

All brand names and logo styles are registered trademarks. Maintaining a policy of continual product development, Pegler Yorkshire reserves the right to change specifications, design and materials of products listed in this publication without prior notice

LIT.REF: 880119